

Attachment A

COUNTY OF NEVADA
STATE OF CALIFORNIA

**BIDDING DOCUMENTS, SPECIFICATIONS
AND CONTRACT DOCUMENTS**

FOR

2023 ROAD REHABILITATION PROJECT

COUNTY PROJECT NO. 450011



BIDS DUE: April 13, 2023, at 2:30 pm

**The County will conduct this public bid opening through the following on-line site:
Nevada County is inviting you to a scheduled TEAMS meeting at
2:30 p.m. April 13, 2023**

Join on your computer, mobile app or room device

[Click here to join the meeting](#)

Meeting ID: 294 385 407 413

Passcode: oqHqHf

[Download Teams](#) | [Join on the web](#)

Or call in (audio only)

[+1 530-414-9282](tel:+15304149282), [905653221#](tel:+1905653221) United States, Truckee

Phone Conference ID: 905 653 221#

(Standard Public Works Contract)

PROFESSIONAL ENGINEERS SIGNATURE PAGE

THE SPECIAL PROVISIONS CONTAINED HEREIN HAVE BEEN PREPARED BY OR UNDER THE DIRECTION OF THE FOLLOWING REGISTERED PERSON.

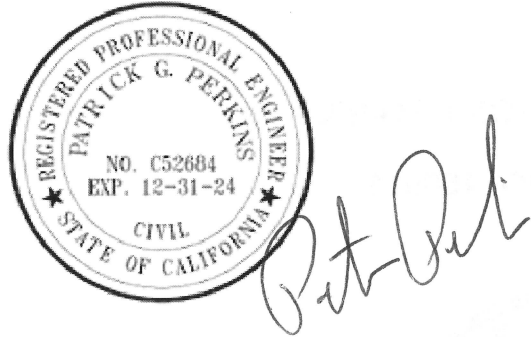

PATRICK PERKINS, REGISTERED CIVIL ENGINEER

TABLE OF CONTENTS

CONTRACT TIME LINE	5
INVITATION TO BID.....	6
INSTRUCTIONS TO BIDDERS	9
CHECKLIST OF DOCUMENTS ENCLOSED BY BIDDER.....	18
BID FORM	21
BIDDER’S BOND	25
EXPERIENCE STATEMENT	27
SUBCONTRACTOR LIST	28
BIDDER’S REPRESENTATIONS.....	29
PUBLIC CONTRACT CODE	30
COUNTY SPECIAL PROVISIONS.....	31
DIVISION I GENERAL PROVISIONS	32
SECTION 1 GENERAL.....	32
SECTION 2 BIDDING.....	33
SECTION 3 CONTRACT AWARD AND EXECUTION.....	33
SECTION 4 SCOPE OF WORK	34
SECTION 5 CONTROL OF WORK	36
SECTION 6 CONTROL OF MATERIALS	38
SECTION 7 LEGAL RELATIONS AND RESPONSIBILITY TO THE PUBLIC	38
SECTION 8 PROSECUTION AND PROGRESS	40
SECTION 9 PAYMENT	41
DIVISION II GENERAL CONSTRUCTION	43
SECTION 10 GENERAL.....	43
SECTION 12 TEMPORARY TRAFFIC CONTROL.....	44
SECTION 13 WATER POLLUTION CONTROL.....	47
SECTION 14 ENVIRONMENTAL STEWARDSHIP	50
DIVISION III EARTHWORK AND LANDSCAPE	51
SECTION 17 GENERAL.....	51
SECTION 19 EARTHWORK.....	52
SECTION 26 AGGREGATE BASES	53
DIVISION V SURFACING AND PAVEMENTS	53
SECTION 37 BITUMINOUS SEALS	53
SECTION 39 ASPHALT CONCRETE.....	56
SECTION 78 INCIDENTAL CONSTRUCTION	58
DIVISION IX TRAFFIC CONTROL DEVICES.....	59
SECTION 81 MISCELLANEOUS TRAFFIC CONTROL DEVICES.....	59
SECTION 82 SIGNS AND MARKERS.....	59
SECTION 84 MARKINGS.....	60
PROJECT MAP	64
APPROXIMATE QUANTITIES BY ROAD	70
CONSTRUCTION DETAILS	71
CONTRACT.....	75
PERFORMANCE BOND	76
CERTIFICATE OF ACKNOWLEDGEMENT	77
PAYMENT BOND.....	78
CERTIFICATE OF ACKNOWLEDGEMENT	79
CONTRACT.....	80
ARTICLE I: DEFINITIONS.....	80
ARTICLE II: SCOPE OF WORK	83
ARTICLE III: CONTRACT TIME	83
ARTICLE IV: CHANGE OF CONTRACT TIME	84
ARTICLE V: CONTRACT PRICE.....	85

ARTICLE VI: CHANGE OF CONTRACT PRICE	85
ARTICLE VII: PAYMENTS TO CONTRACTOR.....	89
ARTICLE VIII: PRELIMINARY MATTERS	93
ARTICLE IX: CHANGES IN THE WORK.....	94
ARTICLE X: CONTRACT DOCUMENTS	95
ARTICLE XI: THE PROJECT SITE	96
ARTICLE XII: PAYMENT AND PERFORMANCE BONDS	98
ARTICLE XIII: CONTRACTOR LIABILITY AND INSURANCE.....	99
ARTICLE XIV: MATERIALS AND EQUIPMENT	102
ARTICLE XV: PLANS AND SPECIFICATIONS.....	104
ARTICLE XVI: SHOP DRAWINGS AND SAMPLES.....	105
ARTICLE XVII: SUBCONTRACTORS, SUPPLIERS AND OTHERS	106
ARTICLE XVIII: PERFORMANCE OF THE WORK.....	107
ARTICLE XIX: TESTS AND INSPECTIONS.....	116
ARTICLE XX: SUSPENSION OF WORK AND TERMINATION.....	119
ARTICLE XXI COUNTY'S AGENT'S STATUS DURING CONSTRUCTION	120
ARTICLE XXII: PARTIAL COMPLETION	123
ARTICLE XXIII: ARBITRATION.....	124
ARTICLE XXIV: LABOR AND EMPLOYMENT	124
ARTICLE XXV: ASSIGNMENT.....	126
ARTICLE XXVI: CONFLICT OF INTEREST RESTRICTIONS.....	126
ARTICLE XXVII: WAIVER OF RIGHTS.....	126
ARTICLE XXVIII: SUCCESSORS IN INTEREST	126
ARTICLE XXIX: NOTICE.....	126
ARTICLE XXX: VENUE AND JURISDICTION.....	127

CONTRACT TIME LINE

1. BIDS DUE: **April 13, 2023, at 2:30 p.m.**
2. BID OPENING: **April 13, 2023, at 2:30 p.m.**
3. BIDS TO REMAIN OPEN FOR **80 DAYS** FROM DATE OF OPENING OF BIDS.
4. NOTICE OF AWARD DUE WITHIN **80 DAYS** OF OPENING OF BIDS. (Construction is anticipated to begin on June 14, 2023)
5. BID BONDS OF UNSUCCESSFUL BIDDERS TO BE RETURNED WITHIN **10 DAYS** OF AWARD BY COUNTY.
6. SIGNED CONTRACT AND BONDS DUE WITHIN **30 DAYS** OF NOTICE OF AWARD.
7. NOTICE TO PROCEED WITH WORK WILL BE ISSUED WITHIN **14 DAYS** OF CONTRACT SIGNING.
8. CONSTRUCTION MUST BEGIN WITHIN **7 DAYS** AFTER ISSUANCE OF NOTICE TO PROCEED.
9. CONTRACTOR MUST GIVE **72 HOURS** WRITTEN NOTICE OF DATE WORK WILL COMMENCE.
10. PRECONSTRUCTION CONFERENCE WITHIN **7 DAYS** OF NOTICE TO PROCEED.
11. SCHEDULES AND BREAKDOWN OF PHASES OF CONSTRUCTION DUE IN **5 DAYS** AFTER RECEIPT OF NOTICE TO PROCEED.
12. **WORK MUST BE COMPLETED WITHIN 40 WORKING DAYS**

COUNTY OF NEVADA
DEPARTMENT OF PUBLIC WORKS

INVITATION TO BID

FOR: 2023 Road Rehabilitation Project

PROJECT NO. – 450011

LOCATED AT: NEVADA COUNTY, CALIFORNIA

Sealed bids will be received at the office of:

Nevada County Purchasing Division Ste 129
Eric Rood Administrative Center
950 Maidu Avenue
Nevada City, CA 95959

Submittals are to be received by mail, or if hand delivered, must be placed in a sealed envelope with the name of the project clearly printed on the front of the envelope and should be delivered to the Purchasing Division in the Eric Rood Administrative Center. All bids will be dated and time-stamped once received by the County representative.

Until **2:30 p.m. April 13, 2023**, local time for the above-referenced project.

Bids received after said time will not be accepted and will be returned unopened.

At said place and time, and promptly thereafter, all bids that have been properly submitted will be publicly opened and read aloud.

The work to be performed includes the following:

The work to be done, in general, consists of paving, performing asphalt repairs, crack sealing, placing shoulder backing, shoulder widening, dirt work, installation of AC dike, removal of existing striping, sweeping roads, microsurfacing, striping, removing old and installing new raised/recessed pavement markers to County maintained roads. The work will be completed in one phase.

Alternative Additive work includes:

The work to be done, in general, consists of traffic control, sweeping roads, microsurfacing, striping. The addition of the add alt item to the contract will be at the discretion of the County of Nevada.

The Engineer's Estimate for this contract is \$1,667,000

Work is anticipated to begin on June 14, 2023

Bids shall be **UNIT PRICES**

Bids must be for all of the work described herein unless the Bid Form specifically indicates a bid item is optional.

Complete work within **40** working days.

The work covered by this bid is not state or federally funded. As such, there are no DBE or DBVE goals and no small Business requirement.

Obtaining Contract Documents: Official copies of the Contract Documents for bidding may be downloaded free of charge at the following link: www.mynevadacounty.com/purchasing. Alternatively, these documents may be purchased for approximately \$40.00 in person at the Purchasing Division, 950 Maidu Ave, Nevada City, CA 95959.

Questions regarding the Work or the contract Documents shall be submitted online on Public Purchase.

Contractor will be required to possess a **CLASS A** contractor's license issued by the state of California contractors license board at the time the bid is submitted. The contractor must be properly licensed as a contractor from contract award through contract completion (Public Contract Code § 10164).

A pre-bid conference or walk-through will **NOT** be held.

DEPARTMENT OF INDUSTRIAL RELATIONS CONTRACTOR REGISTRATION. The Department of Industrial Relations (DIR) has launched an online application at <https://www.dir.ca.gov/Public-Works/Contractor-Registration.html> for public works contractors to meet the requirements of Senate Bill 854. Contractors must register and meet requirements using the new online application before bidding on public works contracts in California.

In accordance with California Labor Code Section 1771.1, a contractor or subcontractor shall not be qualified to bid on, be listed in a Bid Form, subject to the requirements of Section 4104 of the Public Contract Code or engage in the performance of any contract for public work, as defined in this chapter, unless currently registered and qualified to perform public work pursuant to Section 1725.5. Bids cannot be accepted from unregistered contractors except as provided in Section 1771.1.

Contractor and all subcontractors must comply with the requirements of labor code Section 1771.1(a), pertaining to registration of contractors pursuant to Section 1725.5 Registration and all related requirements of those Sections must be maintained throughout the performance of the contract.

This project is subject to compliance monitoring and enforcement by the Department of Industrial Relations. Each contractor and subcontractor must furnish certified payroll records to the Labor Commissioner at least monthly.

The County is required to provide notice to the Department of Industrial Relations of any public work contract subject to prevailing wages within five (5) days of the award. The County of Nevada encourages its contractors and subcontractors to use the US. Citizenship and Immigration Services E-Verify system to verify that employees are eligible to work in the United States. Information about the E-Verify system is available at www.dhs.gov/e-verify.

Each bidder must submit a cashier's check, certified check, or a bidder's bond in an amount equal to 10% of the total amount of the bid. The bidder to whom a contract is awarded will be required to furnish a performance bond and a payment bond guaranteeing faithful performance and payment of all debts related to this contract.

The County of Nevada, in accordance with Title VI of the Civil Rights Act of 1964 (78 Stat. 252) and the regulations of the Department of Commerce (15 C.F.R., Part 8), issued pursuant to such Act, hereby notifies all bidders that it will affirmatively ensure that in any contract entered into pursuant to this advertisement, minority business enterprises will be afforded full opportunity to submit bids in

response to this invitation and will not be discriminated against on the grounds of race, color, or national origin in consideration for an award.

This is a public works project. Pursuant to Sections 1770 and 1773 of the Labor Code of the State of California, the County of Nevada has ascertained that prevailing wage rates are applicable to the work to be done and are available at the State of California Department of Industrial Relations website <http://www.dir.ca.gov/dlsr/PWD/index.htm>. Contractor shall not pay less than the prevailing rate of wages.

No bid will be considered unless it is made on a blank form furnished by the County of Nevada and is made in accordance with the provisions of the bid requirements and conditions set forth in the contract documents.

County reserves the right, acting in its sole discretion, to waive immaterial bid irregularities, to accept or reject any and all bids, or to abandon the Project entirely.

By order of the Nevada County Board of Supervisors, _____.

DATED: _____

COUNTY OF NEVADA
STATE OF CALIFORNIA

By _____
Chair of the Board of Supervisors

INSTRUCTIONS TO BIDDERS

FOR: 2023 Road Rehabilitation Project

LOCATED AT: NEVADA COUNTY, CALIFORNIA

1. DEFINITIONS

Bidder: One who submits a bid directly to County as distinct from a sub-bidder who submits a bid to a bidder.

Successful Bidder: The lowest, qualified, responsive, responsible bidder to whom County makes an award.

Bidding Documents:

Invitation to Bid

Instructions to Bidders

Checklist of Documents Enclosed by Bidder

Bid Form

Bidder's Bond or other security

Experience Statement

Subcontractor List

Bidder's Representations

Proposed Contract Documents

Any and all Addenda

2. COPIES OF BIDDING DOCUMENTS

Complete copies of the bid documents and specifications for use in preparing bids may be obtained in accordance with the Invitation to Bid. Bid documents are also available electronically and can be downloaded from www.mynevadacounty.com/purchasing under the Requests for Bids and Proposals section. Addenda will also be posted to this location. Vendors must register with the County in order to be notified of addendums and other notices. To register, please go to:

<https://www.publicpurchase.com/gems/register/vendor/register>.

Partial sets of bidding documents will not be issued. Complete sets of bidding documents shall be used in preparing bids. County assumes no responsibility for errors or misinterpretations resulting from the use of incomplete sets of bidding documents. If bidder believes its set of bidding documents is incomplete, it shall be the responsibility of bidder to contact County to confirm that Bidder has a complete set.

County, in making copies of bidding documents available on the above terms, does so only for the purpose of obtaining bids on the work and does not confer a license or grant for any other use.

3. QUALIFICATIONS OF BIDDERS

Each bidder must submit, with their bid, written evidence of bidder's qualifications to perform the work. Bidders will be required to submit evidence that they have a practical knowledge of the particular work bid upon, and that they have the financial resources to complete the proposed work. In determining the bidder's qualifications, the following factors will be considered: work previously completed by the bidder and whether the bidder (a) maintains a permanent place of business; (b) has adequate plant and equipment to do the work properly and expeditiously; (c) has the financial resources to meet all obligations incident to the work; and (d) has appropriate technical experience. Each bidder will be required to show that he or she has handled former work so that no just claims are pending against such work. No bid will be accepted without submittal of a completed experience statement form or from a bidder who is engaged on any work which would impair his or her ability to perform or finance this work.

Each bidder must hold a current valid contractor's license at the time of bidding, or the bid will be rejected.

4. INSPECTION OF SITE OF WORK

Bidders are required to inspect the site of the work in order to satisfy themselves, by personal examination or by such other means as they may prefer, of the location of the proposed work and as to the actual conditions of and at the site of work. If, during the course of the examination, bidder finds facts or conditions that appear confusing to bidder, bidder shall apply to County for additional information and explanation before submitting the bid. However, no such supplemental information so requested or furnished shall vary the terms of the specifications or the Contractor's sole responsibility to satisfy himself or herself as to the conditions of the work to be performed, unless an addendum has been issued.

The submission of a bid by the bidder shall constitute the acknowledgement that, if awarded the contract, bidder has relied and is relying on bidder's examination of (a) the site of the work, (b) the access to the site, and (c) all other data, matters, and things requisite to the fulfillment of the work and on bidder's own knowledge of existing conditions on and in the vicinity of the site of the work to be constructed under the contract, and not on any representation or warranty of County. No claim for additional compensation will be allowed which is based upon a lack of knowledge of the above items.

Where technical reports or data have been utilized in the preparation of the contract documents, bidder may rely upon the accuracy of the technical data contained in such reports but not upon the interpretations or opinions contained therein for the completeness thereof for the purpose of bidding or construction.

Where plans and specifications contain drawings of physical conditions in or relating to existing surface conditions, including underground facilities, which are at or contiguous to the site, bidder may rely upon the accuracy of the data contained in such drawings but not upon the completeness thereof for the purposes of bidding or construction. If a mass diagram has been prepared for a project, it is for design purposes only. If it is made available to bidders, County assumes no responsibility whatever for the information contained therein and makes no guarantees with respect to reliance thereon.

Before submitting a bid, each bidder will, at bidder's own expense, make or obtain any additional examinations, investigations, explorations, tests and studies and obtain any additional information and data which pertain to the physical conditions (surface, subsurface and underground facilities) at or contiguous to the site or otherwise which may affect cost, progress, performance or furnishing of the work and which bidder deems necessary to determine its bid for performing and furnishing the work in accordance with the time, price and other terms and conditions of the contract documents.

On request in advance, County will provide each bidder access to the site to conduct such explorations and tests, as each bidder deems necessary for the submission of a bid. Bidder shall fill all holes, clean up and restore the site to its former condition upon completion of such explorations.

The lands upon which the work is to be performed, rights-of-way and easements for access thereto and other lands designated for use by Contractor in performing the work are identified in the contract documents. All additional lands and access thereto required for temporary construction facilities or storage of materials and equipment are to be provided by Contractor. Easements for permanent structures or permanent changes in existing structures are to be obtained and paid for by County unless otherwise provided in the contract documents.

5. EXAMINATION OF CONTRACT DOCUMENTS

The contract documents shall consist of the following:

1. Invitation to Bid;
2. Instructions to Bidders;
3. Contractor's Bid (including documentation accompanying the Bid and any post-bid documentation submitted prior to the Notice of Award);
4. Contract;
5. Addenda which pertain to the Contract;
6. The Bonds or other security;
7. Any supplementary conditions or any and all written agreements amending or extending the work, time, or price contemplated;
8. The Plans, Specifications and Estimate (PS&E) including Special Provisions, and Drawings as identified in the Contract;
9. Certificates of Insurance;
10. Other: _____

Each bidder shall thoroughly examine and be familiar with legal and procedural documents, general conditions, Specifications, drawings, and addenda (if any). The submission of a bid shall constitute an acknowledgement upon which County may rely that the bidder has thoroughly examined and is familiar with the contract documents. The failure or neglect of a bidder to receive or examine any of the contract documents shall in no way relieve that bidder from any obligation with respect to that bidder's bid or to the contract. No claim for additional compensation will be allowed which is based upon a lack of knowledge of any contract documents.

6. INTERPRETATION OF CONTRACT DOCUMENTS

No oral representations or interpretations will be made to any bidder as to the meaning of the contract documents. Any ambiguities, inconsistencies in the plans and specifications or other contract documents, or problems which are visible by an inspection of the site or review of the contract documents shall be resolved prior to bidding. Request for an interpretation shall be made in writing and delivered to County at least ten (10) days before the time announced for opening of the bids. Interpretations by County will be in the form of an addendum to the contract documents and, when issued, will be sent as promptly as is practical to all parties to whom the bid documents have been issued. All such addenda shall become part of the contract. County reserves the right to amend any contract language, which it determines, is ambiguous prior to award of the bid.

7. ADDENDA

Each bid shall include specific acknowledgment, in the space provided, of receipt of all addenda issued during the bidding period. Failure to so acknowledge will result in the bid being rejected as not responsive. The Contractor is responsible for verifying that all addenda have been received and for obtaining all addenda prior to submitting bids for the work.

Only questions answered by formal written addenda will be binding. Oral and other interpretations or clarifications will be without legal effect.

Addenda may also be issued to modify the bidding documents as deemed advisable by County.

No addenda will be issued later than four (4) days prior to the date for receipt of bids except an addendum, if necessary, postponing the date for receipt of bids or withdrawing the request for bids.

8. BIDS

Bids shall be made on the blank forms prepared by County and included herein. Bidders may extract these pages from the book of specifications or submit the entire book. All bids shall give prices, both in writing and in figures, and shall be signed by the bidder or bidder's authorized representative with bidder's address and shall provide all other information requested on the Bid Form. If the bid is made by an individual, his or her name, signature and post office address must be shown; if made by a firm or partnership, the name and post office address of the firm or

partnership must be shown; if made by a corporation, the bid shall show the name of the state under the laws of which the corporation is chartered, the name and post office address of the corporation, and the title of the person who signs on behalf of the corporation.

9. SUBMISSION OF BIDS

Bids shall be submitted at the time and place indicated in the Invitation for Bid and shall be included in a sealed envelope addressed to the Nevada County Purchasing Division. If mailed, the bids shall be addressed to:

USPS, Fed Ex, UPS, etc. to:

Nevada County Purchasing Division **or**
Eric Rood Administrative Center
950 Maidu Avenue
Nevada City, CA 95959

Hand deliver to:

Nevada County Purchasing Division
Suite 129
Eric Rood Administrative Center
950 Maidu Avenue
Nevada City, CA 95959

The bid shall be identified on the outside with the bidder's name, license number and address and with the project title: **2023 Road Rehabilitation Project**

Each bid shall be accompanied by the bid security and other required documents.

If the bid is sent by mail, the sealed envelope shall be enclosed in a separate mailing envelope with the notation "BID ENCLOSED" on the face thereof.

Bids shall be deposited at the designated location prior to the time and date for receipt of bids indicated in the Invitation to Bid, or the modified time and date indicated by addendum. Bids received after the time and date for receipt of bids will be returned unopened. Bidder shall assume full responsibility for timely delivery at the location designated for receipt of bids.

Oral, telephone, or fax bids are invalid and will not receive consideration. No bidder may submit more than one bid. Multiple bids under different names will not be accepted from one firm or association.

10. PRE-BID CONFERENCE OR WALK-THROUGH

A pre-bid conference or walk-through will **not** be held.

11. BID PRICE

The bid price shall include everything necessary for the completion of construction and fulfillment of the contract including, but not limited to, furnishing all materials, equipment, tools, plant and other facilities and all management, superintendence, labor, and services, except as may be provided otherwise in the contract documents.

In the event of a difference between the price quoted in words and a price quoted in figures for the same quotation, the words shall be considered the amount bid. Discrepancies between the indicated sum or total of figures and the correct sum or total will be resolved in favor of the correct sum or total.

12. BASIS OF BIDS

The bidder shall submit both a lump sum price and prices for all unit cost items and alternatives shown on the Bid Form. Failure to comply may be cause for rejection.

Where specific quantities are given, they are approximate only, being given as a basis for the comparison of bids, and the County of Nevada does not, expressly or by implication, warrant that the actual amount of work will correspond therewith, but reserves the right to increase or decrease the amount of any class or portion of the work or to omit portions of the work as may be deemed necessary or advisable by County. The amount of the bid for comparison purposes will be the total of all items. The total of unit basis items will be determined by extension of the item price bid on the basis of the estimated quantity set forth for the item.

The bidder shall set forth for each item of work in clearly legible figures, an item price, and a total for the item in the respective spaces provided for this purpose. In the case of unit basis items, the amount set forth under the "Total" column shall be the extension of the item price bid on the basis of the estimated quantity for the item.

In case of discrepancy between the item price and the total set forth for the item, the item price shall prevail; however, if the amount set forth as an item price is ambiguous, unintelligible or uncertain for any cause, or is omitted, or in the case of unit basis items is the same amount as the entry in the "Total" column, then the amount set forth in the "Total" column for the item shall prevail in accordance with the following:

- a. As to unit basis items, the amount set forth in the "Total" column shall be divided by the estimated quantity for the item and the price thus obtained shall be the item price.
- b. As to the lump sum items, the amount set forth in the "Total" column shall be the item price.

In accordance with the provision of Section 6707 of the State Labor Code, each bidder shall list, in any bid item calling for trenching of five (5) feet or more in depth, the amount contained in the bid for adequate trench and excavation sheeting, shoring, and bracing or equivalent method for the protection of life and limb which shall conform to applicable Safety Orders.

13. TAXES

Bid prices shall include allowance for all federal, state, and local taxes.

14. CONTRACT TIME

The date by which the work is to be completed (the contract time) is set forth in the Invitation to Bid and contract documents.

15. SUBSTITUTE MATERIAL AND EQUIPMENT

The contract, if awarded, will be on the basis of material and equipment described in the drawings or specified in the specifications without consideration of possible substitute or "co-equal" items. Whenever it is indicated in the drawings or specified in the specifications that a substitute or "co-equal" item of material or equipment may be furnished or used by Contractor if acceptable to County, application for such acceptance will not be considered by County until after the effective date of the contract unless an addendum is issued to all bidders authorizing the use of a specified substitute. The procedure for submittal of any such application by Contractor and consideration by County is set forth in the contract documents.

16. SUBCONTRACTOR LIST

Each bid shall have listed on the form provided herewith the name and address of each subcontractor to whom the bidder proposes to sublet portions of the work in excess of one-half of one percent of the total amount of the bid or \$10,000, whichever is greater, per Public Contracts Code Sections 4104. For the purpose of this paragraph, a subcontractor is defined as one who contracts with the Contractor to furnish materials and labor, or labor only for the performance of work at the site of the work.

County has the right to review the suitability and qualifications of any subcontractor or supplier proposed by the Contractor. As part of this review County may request an experience statement with pertinent information as to similar projects and other evidence of qualification for each subcontractor, person, and organization. If County, after due investigation, has reasonable objection to any proposed subcontractor, County may, before giving the notice of award, request the apparent successful bidder to submit an acceptable substitute without an increase in bid price. If the apparent successful bidder does not make such substitution, the contract shall not be awarded to such bidder, but Contractor's failure to make such substitution will not constitute grounds for sacrificing the bid security. Any subcontractor, other person or organization so listed and to whom County does not make written objection prior to the giving of the notice of award will

be deemed acceptable to County subject to revocation of such acceptance after the effective date of the agreement as provided in the contract documents.

No Contractor shall be required to employ any subcontractor, other person, or organization against whom Contractor has reasonable objection.

The Contractor may not change any subcontractor listed on its bid without written approval from County after a determination that the requirements of Public Contracts Code Section 4107 have been met.

17. BID GUARANTY (BID BOND)

The bid shall be accompanied by a bid guaranty bond (bid bond) duly completed on the form provided herewith or a form which is substantially similar, by a guaranty company authorized to carry on business in the State of California, for payment to County in the sum of at least ten (10%) percent of the total amount of the bid, or alternatively by a certified or cashier's check, payable to County in the sum of at least ten (10%) percent of the total amount of the bid. A bid bond form which provides further payment of attorney's fees, or which contains a termination date will not be considered to be "substantially similar". The amount payable to County under the guaranty bond, or the certified or cashier's check and the amount thereof, as the case may be, shall be forfeited to County as liquidated damages in case of a failure or neglect of the bidder to furnish, execute and deliver to County the required performance and payment bonds, evidence of insurance, and to enter into, execute and deliver to County the contract on the form provided herewith, within **14 days** after being notified in writing by County that the award has been made and the agreement is ready for execution.

All bonds shall have a power of attorney authorizing the signature of the person authorized to sign on behalf of the Surety attached to the bond. The power of attorney signature and the principal's signature shall each (both) be notarized.

The bid bond shall name County as beneficiary and shall specify that the bond is valid for the bid opening of this project as scheduled in the Invitation to Bid.

18. RETURN OF BID GUARANTEES

Within **ten (10) days** after the bids are awarded, County will return the bid guarantees (other than bid bonds) accompanying the bids for bids not considered in making the award. All other bid guaranties will be held until the contract has been fully executed, after which they will be returned to the respective bidders whose bids they accompany.

19. MODIFICATION OR WITHDRAWAL OF BIDS

Bids submitted early may be modified or withdrawn by notice to the party receiving bids at the place and prior to the time designated for receipt of bids. Such notice shall be in writing over the signature of the bidder or be by fax; if by fax, written confirmation over the signature of bidder must have been mailed and postmarked on or before the date and time set for receipt of bids; it shall be so worded as not to reveal the amount of original bid. Bids may also be modified or withdrawn in person by the bidder, or an authorized representative provided bidder can prove bidder's identity and authority. Withdrawn bids may be resubmitted up to the time designated for the receipt of bids provided that they are then fully in conformance with these instructions to bidders.

If, within 24 hours after bids are opened, any bidder files a duly signed written notice with County and promptly thereafter demonstrates to the reasonable satisfaction of County that there was a material and substantial mistake in the preparation of the bid, that bidder may withdraw his or her bid and the bid security will be returned. Thereafter, that bidder will be disqualified from further bidding on the work.

20. OPENING OF BIDS

Bids will be opened publicly and read aloud. An abstract of the amounts of the base bids and major alternates (if any) will be made available after the opening of the bids.

21. BIDS TO REMAIN OPEN

All bids shall remain open and subject to acceptance for a period of **80 days** from the date of opening, but County may, in County's discretion, release any bid and return the bid security prior to that date.

22. POSTPONEMENT OF OPENING

County reserves the right to postpone the date and time for opening of bids at any time prior to the date and time announced in the advertisement.

23. AWARD OF CONTRACT-PROTESTS

The Contract, if it is awarded, will be awarded to the lowest responsible bidder whose bid complies with the requirements set forth herein. The lowest bidder shall be the bidder submitting the lowest price for the work as specified.

Within **80** days after the time of opening the bids, County will act either to accept a bid or to reject all bids. The acceptance of a bid will be evidenced by a notice of award of contract in writing.

County will use email to notify bidders of the decision of the County on the award of this Bid. Therefore, it is essential that bidders identify one or more contact persons on the Bid Form who have frequent access to email. The County will not be responsible for delivery failure of email due to firewalls, spam filters, or individuals' failure to retrieve email messages. The County will not attempt to re-deliver any messages which fail due to no fault of the County.

The award of contract shall obligate the bidder whose bid is accepted to furnish a performance bond, payment bond, warranty bond, and evidences of insurance (certificates of insurance and endorsements specified in the contract) and execute the agreement set forth in the contract documents.

In addition, but not limited to the following, the County reserves the right to reject any and all bids and to waive any and all formalities, and the right to disregard all nonconforming, non-responsive, or conditional bids. County reserves the right to reject the bid of any bidder if County believes that it would not be in the best interest of the project to make an award to that bidder, whether because the bid is not responsive, or the bidder is unqualified or of doubtful financial ability or fails to meet any other pertinent standard or criteria established by County. County reserves the right to reject any bids which omit a bid on any one or more items on which bids are required; any bids which omit unit prices if unit prices are required; any bids in which unit prices are unbalanced in the opinion of County; any bid accompanied by insufficient or irregular bid security; and any bids from bidders who have previously failed to perform properly or to complete on time contracts of any nature.

County may consider the qualifications and experience of subcontractors and other persons and organizations (including those who are to furnish the principal items of material or equipment) proposed for those portions of the work as to which the identity of subcontractors and other persons and organizations must be submitted as provided herein. Operating costs, maintenance considerations, performance data and guarantees of materials and equipment may also be considered by County.

If there is reason to believe that collusion exists among the bidders, none of the bids of the participants in such collusion will be considered, and County may likewise elect to reject all bids received.

Protests and Appeals:

Bid Protest. Any bid protest must be in writing, received by the Purchasing Agent at the Rood Administrative Center, 950 Maidu Avenue, Suite 130, Nevada City, CA, before 5:00 p.m. no later than five working days following the notice of intent to award (herein referred to as the Bid Protest Deadline), and must comply with the following requirements:

1. General. Only a bidder who has actually submitted a Bid Form is eligible to submit a bid protest. Subcontractors are not eligible to submit bid protests. A bidder may not rely on the bid protest submitted by another bidder but must timely pursue its own protest. If required by County, the protesting bidder must submit a non-refundable fee in the amount specified by County, based upon County's reasonable costs to administer the bid protest. Any such fee must be submitted to County no later than the Bid Protest Deadline, unless otherwise specified. For purposes of this Section 1, a "working day" means a day that County is open for normal business, and excludes weekends and holidays observed by County.
2. Protest Contents. The bid protest must contain a complete statement of the basis for the protest and all supporting documentation. Material submitted after the Bid Protest Deadline will not be considered. The protest must refer to the specific portion or portions of the documents upon which the protest is based. The protest must include the name, address, email address, and telephone number of the person representing the protesting bidder if different from the protesting bidder.
3. Copy to Protested Bidder(s). A copy of the protest and all supporting documents must be concurrently transmitted by fax or by email, by or before the Bid Protest Deadline, to the protested bidder and any other bidder who has a reasonable prospect of receiving an award depending upon the outcome of the protest.
4. Bidders Response to Protest. The protested bidder may submit to the County a written response to the protest, provided the response is received before 5:00 p.m., within two working days after the Bid Protest Deadline or after actual receipt of the bid protest, whichever is sooner (the "Response Deadline"). The response must include all supporting documentation. Material submitted after the Response Deadline will not be considered. The response must include the name, address, email address, and telephone number of the person representing the protested bidder if different from the protested bidder.
 - 4.1 Copy to Protesting Bidder. A copy of the response and all supporting documents must be concurrently transmitted by fax or by email, by or before the Bid Protest Deadline, to the protesting bidder and any other bidder who has a reasonable prospect of receiving an award depending upon the outcome of the protest.
5. Exclusive Remedy. The procedure and time limits set forth in this section are mandatory and are the bidder's sole and exclusive remedy in the event of bid protest. A bidder's failure to comply with these procedures will constitute a waiver of any right to further pursue a bid protest, including filing a Government Code Claim or initiation of legal proceedings.
6. Right to Award. The County Board of Supervisors reserves the right to award the Contract to the bidder it has determined to be the responsive, responsible bidder submitting the lowest bid, and to issue a notice to proceed with the Work notwithstanding any pending or continuing challenge to its determination.

24. SIGNING OF AGREEMENT

When County gives a Notice of Award to the successful bidder, it will be accompanied by unsigned counterparts of the agreement and all other contract documents.

Three (3) copies of the contract documents will be prepared by County. All copies will be submitted to Contractor, and Contractor shall execute the contract, insert executed copies of the required bonds and power of attorney, and submit all copies to County within **30 days**. The date of execution of the contract shall be left blank for filling in by County.

County will execute all copies, insert the date of signing the contract on the contract and bond forms and on the power-of-attorney and distribute one copy each to County and Contractor. Contractor shall be responsible for distribution of copies to the Surety(ies).

Notwithstanding any action by County to the contrary or by the Board of Supervisors in accepting a bid, there shall be no contract between bidder and County until the contract documents are signed by County.

Failure of the Contractor to execute the contract within the specified time shall be just cause for withdrawal of the contract award by the County and forfeiture by the Contractor of the bid guaranty bond.

25. NOTICE TO PROCEED

County shall give the successful bidder written notice to proceed with the work within **14 days** of the execution of the contract. Notwithstanding any other provision of the contract, County shall not be obligated to accept or to pay for any work furnished by the Contractor prior to delivery of notice to proceed whether or not County has knowledge of the furnishing of such work.

26. PERFORMANCE AND OTHER BONDS

The contract documents set forth County's requirements as to performance and other bonds. When the successful bidder delivers the executed contract to County, it shall be accompanied by the required contract security. The bonds shall be provided on County's forms or on forms which are substantially similar. Notwithstanding any language contained in the bonds, County shall not be liable for attorney's fees either for the enforcement of the bond or for any other action under this Contract. Bonds shall not contain any date of termination.

27. CONTRACTUAL RESTRICTIONS

No official of County who is authorized in such capacity and on behalf of County to negotiate, make, accept, or approve, or to take part in negotiating, making, accepting, or approving any architectural, engineering, inspecting, construction or material supply contract or any subcontract in connection with the construction of the project, shall become directly or indirectly interested personally in this contract or in any part thereof. No officer, employee, architect, attorney, engineer, or inspector of or for County who is authorized in such capacity and on behalf of County who is in any legislative, executive, supervisory, or other similar function in connection with the construction of the project, shall become directly or indirectly interested personally in this contract or in any part thereof, any material supply contract, subcontract, insurance contract, or any other contract pertaining to the project.

28. POSTING SECURITY IN LIEU OF RETENTION

The Contractor may elect to receive one hundred percent (100%) of payments due under this contract from time to time, without retention of any portion of the payment by the public agency, by depositing securities of equivalent value with County in accordance with the provisions of Section 22300 of the California Public Contract Code; except that no such substitution shall be allowed where federal money is funding the project and federal regulations or policies would prohibit such substitution of securities for the retention. Securities eligible for investment shall include those listed in Section 16430 of the California Government Code, or bank or savings and loan certificates of deposits. Such securities, if deposited by the bidder, shall be valued by County whose decision on the valuation of the securities shall be final. The bidder shall be the beneficial owner of any securities substituted for money withheld and shall receive any interest thereon.

29. LIQUIDATED DAMAGES

The County is authorized by Government Code Section 53069.85 to assess liquidated damages for delay. County refers bidders to the Contract for review of the liquidated damages provision to be included in this contract.

CHECKLIST OF DOCUMENTS ENCLOSED BY BIDDER

Bidder shall acknowledge he or she has enclosed all required Bidding Documents listed herein by signing his or her initials in "Bidder" column, after each item.

DOCUMENT	SIGNATURES	
	BIDDER	COUNTY REP.
1. BID FORM (signed)		
2. ACKNOWLEDGMENT OF ADDENDA		
3. BID SECURITY: Bid Bond (must be signed by corporate surety); or Cashier's check; or Certified Check; or Cash		
4. EXPERIENCE STATEMENT (signed)		
5. SUBCONTRACTOR LIST (signed)		
6. BIDDER'S REPRESENTATIONS: (BIDDER'S QUALIFICATIONS, WORKER'S COMPENSATION CERTIFICATION, NONCOLLUSION DECLARATION)		
7. PUBLIC CONTRACT CODE: 10285.1, 10162, AND 10232 (signed)		

Bids are to be submitted for the entire work. The amount of the bid for comparison purposes will be the total of all items.

The bidder shall set forth for each unit basis item of work a unit price and a total for the item, and for each lump sum item a total for the item, all in clearly legible figures in the respective spaces provided for that purpose. In the case of unit basis items, the amount set forth under the "Item Total" column shall be the product of the unit price bid and the estimated quantity for the item.

In case of discrepancy between the unit price and the total set forth for a unit basis item, the unit price shall prevail, except as provided in (a) or (b), as follows:

- (a) If the amount set forth as a unit price is unreadable or otherwise unclear, or is omitted, or is the same as the amount as the entry in the item total column, then the amount set forth in the item total column for the item shall prevail and shall be divided by the estimated quantity for the item and the price thus obtained shall be the unit price;
- (b) (Decimal Errors) If the product of the entered unit price and the estimated quantity is exactly off by a factor of ten, one hundred, etc., or one-tenth, or one-hundredth, etc. from the entered total, the discrepancy will be resolved by using the entered unit price or item total, whichever most closely approximates percentage-wise the unit price or item total in the *COUNTY OF NEVADA's* Final Estimate of cost.

If both the unit price and the item total are unreadable or otherwise unclear, or are omitted, the bid may be deemed irregular. Likewise if the item total for a lump sum item is unreadable or otherwise unclear, or is omitted, the bid may be deemed irregular unless the project being bid has only a single item and a clear, readable total bid is provided.

Symbols such as commas and dollar signs will be ignored and have no mathematical significance in establishing any unit price or item total or lump sums. Written unit prices, item totals and lump sums will be interpreted according to the number of digits and, if applicable, decimal placement. Cents symbols also have no significance in establishing any unit price or item total since all figures are assumed to be expressed in dollars and/or decimal fractions of a dollar. Bids on lump sum items shall be item totals only; if any unit price for a lump sum item is included in a bid and it differs from the item total, the items total shall prevail.

The foregoing provisions for the resolution of specific irregularities cannot be so comprehensive as to cover every omission, inconsistency, error or other irregularity which may occur in a bid. Any situation not specifically provided for will be determined in the discretion of the *COUNTY OF NEVADA*, and that discretion will be exercised in the manner deemed by the *COUNTY OF NEVADA* to best protect the public interest in the prompt and economical completion of the work. The decision of the *COUNTY OF NEVADA* respecting the amount of a bid, or the existence or treatment of an irregularity in a bid, shall be final.

If this bid shall be accepted and the undersigned shall fail to enter into the contract and furnish the 2 bonds in the sums required by the State Contract Act, with surety satisfactory to the *COUNTY OF NEVADA*, within 30 days, not including Saturdays, Sundays and legal holidays, after the bidder has received notice from the *COUNTY OF NEVADA* that the contract has been awarded, the *COUNTY OF NEVADA* may, at its option, determine that the bidder has abandoned the contract, and thereupon this bid and the acceptance thereof shall be null and void and the forfeiture of the security accompanying this bid shall operate and the same shall be the property of the *COUNTY OF NEVADA*.

The undersigned, as bidder, declares that the only persons or parties interested in this bid as principals are those named herein; that this bid is made without collusion with any other person, firm, or corporation; that he has carefully examined the location of the proposed work, the annexed proposed form of contract, and the plans therein referred to; and he proposes, and

agrees if this bid is accepted, that he will contract with the *COUNTY OF NEVADA*, in the form of the copy of the contract annexed hereto, to provide all necessary machinery, tools, apparatus and other means of construction, and to do all the work and furnish all the materials specified in the contract, in the manner and time therein prescribed, and according to the requirements of the Engineer as therein set forth, and that he will take in full payment therefore the following prices, to wit:

BID FORM

(Nevada County Standard Form Bid Document)

BID TO THE COUNTY OF NEVADA FOR: _____

Name of Bidder: _____

The work to be done and referred to herein is in Nevada County, State of California, and shall be constructed in accordance with the Plans, Specifications (including the payment of not less than the wage rates set forth therein) and the Contract annexed hereto.

The work to be done is shown on project documents entitled: _____

The undersigned, as bidder, declares that the only persons or parties interested in this bid as principals are those named herein; that this bid is made without collusion with any other person, firm, or corporation, and in submitting this bid, the undersigned bidder agrees that he or she has carefully examined the location of the proposed work, the annexed proposed form of contract, and the plans therein referred to and all other documents listed or incorporated in the bidding documents and contract documents; and bidder proposes, and agrees if this bid is accepted, that bidder will contract with the County of Nevada in the form of the copy of the contract annexed hereto, to provide all necessary machinery, tools, apparatus, and other means of construction, and to do all the work and furnish all the materials specified in the contract, in the manner and time therein prescribed, and according to the requirements of County as therein set forth, and that bidder will take in full payment therefor the following:

BID SHEET

Item No.	Item	Unit of Measure	Estimated Quantity	Item Price	Total
1.	Traffic Control	LS	1		
2.	Water Pollution Control Plan	LS	1		
3.	Clearing and Grubbing	LS	1		
4.	Dig out & repair	SF	21,375		
5.	Shoulder Backing	CY	285		
6.	Crack Treatment	LANE FOOT	40,448		
7.	Shoulder Widening	LF	5,125		
8.	Micro-surfacing Type II w/ Latex	SF	187,160		
9.	Fiber Reinforced HMA 64-16	TONS	4,380		
10.	Install County Furnished Sign	EA	2		
11.	Remove & Replace Recessed Pavement Markers	EA	1,685		
12.	Detail 38A 8" Paint (White)	LF	48		
13.	Detail 21 4" Paint (Yellow w/ Black)	LF	20,224		
14.	Detail 27B 4" Paint (White)	LF	40,448		
15.	AC Dike Type A	LF	1,675		
16.	Road Marking Removal	LF	60,671		
			Total		

TOTAL OF BID (In Figures): _____

TOTAL OF BID (In Words): _____

ALTERNATE/ADDITIVE BID SHEET

Item No.	Item	Unit of Measure	Estimated Quantity	Item Price	Total
A. Gold Country Drive – See Map Page 64					
A1.	Traffic Control	LS	1		
A2.	Micro-surfacing Type II w/ Latex	SF	96,217		
A3.	Detail 22 4" Paint (Yellow)	LF	3,672		
			Total		

TOTAL OF ALTERNATE/ADDITIVE BID (In Figures):

TOTAL OF ALTERNATE/ADDITIVE BID (In Words):

Bidder shall bid each item. Failure to bid an item shall be just cause for considering the bid as non-responsive. County reserves the right to reject all bids

The undersigned bidder agrees to furnish the required bonds or other security and to enter into a contract within the time specified in the Instructions to Bidders, and further agrees to complete all work by the bid, in accordance with all requirements of the contract.

The undersigned, as bidder, declares that the only persons or parties interested in this bid as principals are those named herein; that this bid is made without collusion with any other person, firm, or corporation, and in submitting this bid, the undersigned bidder agrees that he or she has carefully examined the location of the proposed work, the annexed proposed form of contract, and the plans therein referred to and all other documents listed or incorporated in the bidding documents and contract documents; and bidder proposes, and agrees if this bid is accepted, that bidder will contract with the County of Nevada in the form of the copy of the contract annexed hereto, to provide all necessary machinery, tools, apparatus, and other means of construction, and to do all the work and furnish all the materials specified in the contract, in the manner and time therein prescribed, and according to the requirements of County as therein set forth, and that bidder will take in full payment therefor the following

Contract shall be awarded based upon the Base Bid Package (Items 1 – 16)

Receipt of copies of the following addenda is hereby acknowledged.

<u>Addendum No.</u>	<u>Bidder's Signature</u>	<u>Date Acknowledged</u>
_____	_____	_____
_____	_____	_____
_____	_____	_____
_____	_____	_____
_____	_____	_____

All addenda received have been considered in preparation of this bid.

Enclosed herewith are the Bid Form, Bid Bond or other security, Experience Statement, Subcontractor List and Bidder's Representations form and Public Contract Code form.

In submitting this bid it is understood that the right is reserved by County to reject any and all bids, and it is understood that this bid may not be withdrawn during the period set forth in the Instructions to Bidders.

Envelopes containing bids must be marked as required by the Instructions to Bidders.

County reserves the right to reject any and all bids and to waive any irregularities in bids.

The amount of the bid for comparison purposes will be the total of all items. The total of unit basis items will be determined by extension of the item price bid on the basis of the estimated quantity set forth for the item.

Prices bid shall include overhead profit and all applicable taxes.

By submission of this bid, each bidder certified, and in the case of a joint bid each party thereto certifies as to its own organization, that this bid has been arrived at independently, without consultation, communication, or agreement as to any matter relating to this bid with any other bidder or with any competitor.

A bid bond will accompany this bid in a sum of not less than ten percent (10%) of the total amount of the bid and shall be on a form approved by County or a form which is substantially similar, which is attached thereto.

If this bid shall be accepted and the undersigned shall fail to contract as aforesaid, and to give the performance bond and payment bond as required in the contract with a surety satisfactory to County within the number of days set forth in the Instructions to Bidders after receipt of notice that the contract has been awarded to the undersigned, County may, at its option, determine that the bidder has abandoned the contract and thereupon the award of the contract shall be null and void and the bidder and surety shall forfeit the security accompanying this bid to the County of Nevada.

Accompanying this bid is:

("Bidder's Bond", "Cashier's Check", "Certified Check" or "Cash")

for \$_____ an amount equal to ten percent (10%) of the total bid.

The names of individuals who are principals in any partnership, joint venture, business association or corporation in the foregoing bid are as follows:

Licensed in accordance with an act providing for the registration of contractors, License No.

Dated: _____

Authorized Signature of Bidder(s)

BUSINESS ADDRESS: _____

CITY, STATE & ZIP CODE: _____

TELEPHONE NUMBER: _____

EMAIL ADDRESS: _____

CLASSIFICATION OF CONTRACTOR'S LICENSE: _____

EXPIRATION DATE OF CONTRACTOR'S LICENSE: _____

DIR# _____ FEDERAL TAX ID. No.: _____

NOTE: If bidder is a corporation, the legal name of the corporation shall be set forth above together with the signature of the officer or officers authorized to sign contracts on behalf of the corporation; if bidder is a co-partnership, the true name of the firm shall be set forth above together with the signature of the partner or partners authorized to sign contracts on behalf of the co-partnership; and if bidder is an individual, his or her signature shall be placed above. If a bidder is a joint venture, the documents must be signed by an authorized officer of each firm to the joint venture and shall include the California Contractor's License number of each partner to the joint venture. The signature of any attorney-in-fact must be notarized.

BIDDER'S BOND

STATE OF CALIFORNIA
COUNTY OF NEVADA

KNOW ALL PERSONS BY THESE PRESENT,

That we _____

_____, as contractor, and _____

as surety, are held and firmly bound unto the County of Nevada in the sum of ten percent (10%) of the total amount of the bid of the contractor above named, submitted by said contractor to the County of Nevada for the work described below, for the payment of which sum in lawful money of the United States, well and truly to be made, to the County of Nevada, we bind ourselves, our heirs, executors, administrators, and successors, jointly and severally, firmly by these presents. In no case shall the liability of the surety hereunder exceed the sum of \$_____.

The condition of this obligation is such that whereas the contractor has submitted the above-mentioned bid to the County of Nevada, as aforesaid, for certain construction specifically described as follows, for which bids are to be opened at Nevada City, California, on _____, for:

NOW, THEREFORE, if the aforesaid contractor is awarded the contract, and within the time and manner required by the contract documents, after the prescribed forms are presented to him or her for signature, enters into a written Contract, in the prescribed form, in accordance with the bid, and files two bonds with the County of Nevada, one to guarantee faithful performance and the other to guarantee payment for labor and materials, as required by law, then this obligation shall be null and void; otherwise it shall be and remain in full force and effect.

Notice to Surety shall be provided at:

IN WITNESS WHEREOF, we have hereunto set our hands and seals on this _____ day of _____ A. D. 20_____.

_____ Seal

_____ Seal

_____ Seal
Contractor

_____ Seal

_____ Seal

_____ Seal
Surety

NOTE: Signature of Surety shall be notarized. Power of attorney for surety with corporate seal affixed must be attached.

EXPERIENCE STATEMENT

The following outline is a record of the bidder's or subcontractor's recent experience in construction of a type similar in magnitude and character to that contemplated under this contract. Additional numbered pages shall be attached to this page as required. Each page shall be headed "Experience Statement" and signed.

FAILURE TO COMPLETE WILL RESULT IN BID DISQUALIFICATION

1.) PROJECT NAME: _____
DATE: _____
INSPECTOR NAME _____
PHONE # _____
CONTRACT AMOUNT: _____
WORK PERFORMED: _____

2.) PROJECT NAME: _____
DATE: _____
INSPECTOR NAME _____
PHONE # _____
CONTRACT AMOUNT: _____
WORK PERFORMED: _____

3.) PROJECT NAME: _____
DATE: _____
INSPECTOR NAME _____
PHONE # _____
CONTRACT AMOUNT: _____
WORK PERFORMED: _____

4.) PROJECT NAME: _____
DATE: _____
INSPECTOR NAME _____
PHONE # _____
CONTRACT AMOUNT: _____
WORK PERFORMED: _____

Signature of Contractor

SUBCONTRACTOR LIST

Listed hereunder is the name, Contractor's license number, the address of place of business, and the category of the work on the Contract for each subcontractor who will perform work or labor or render service to the undersigned bidder in or about the construction of the work hereinabove described, in excess of one-half of one percent (0.5%) of the total bid, if the contract for the said work is awarded to the undersigned.

(Attach additional sheet, if necessary, and note attachment on this page.)

Name of Subcontractor	Contractor's License #	DIR Registration Number	Location of Business	Category of Work To Be Performed	% of Total Work

Signature of Contractor/Bidder: _____

(THE BIDDER'S EXECUTION ON THE SIGNATURE PORTION OF THIS BID FORM SHALL ALSO CONSTITUTE AN ENDORSEMENT AND EXECUTION OF THOSE CERTIFICATIONS WHICH ARE A PART OF THIS BID)

BIDDER'S REPRESENTATIONS

I, the undersigned, declare as follows:

1. **BIDDER'S QUALIFICATIONS:** That neither I nor a company of which I am more than 50% owner have been disqualified from bidding, removed from a public works construction project, or otherwise been prevented from bidding because of a violation of law or a safety regulation.

Further, I declare under penalty of perjury that neither I nor a company of which I am more than a 50% owner, have had more than one final, unappealable finding of contempt of court by a federal court within the immediately preceding two-year period because of failure to comply with an order of the Federal court (Public Contract Code Section 10232), which orders the Contractor to comply with an order of the National Labor Relations Board.

Further, I declare under penalty of perjury that I have not been convicted by any court of any charge of fraud, bribery, collusion, conspiracy, or any other act in violation of state or federal antitrust law in connection with the bidding upon, award of, or performance of any public works contract.

2. **WORKER'S COMPENSATION CERTIFICATION (LABOR CODE SECTION 1861):** That I am aware of the provisions of Section 3700 of the Labor Code of the State of California, which requires every employer to be insured against liability for Worker's Compensation or to undertake self-insurance in accordance with the provisions of that Code, and I will comply with such provisions before commencing the performance of the work of this Contract.

3. **NONCOLLUSION DECLARATION:** I, the undersigned, declare that I am the _____ of _____, the party making the foregoing bid, that the bid is not made in the interest of, or on behalf of, any undisclosed person, partnership, company, association, organization, or corporation; that the bid is genuine and not collusive or sham; that the bidder has not directly or indirectly induced or solicited any other bidder to put in a false or sham bid, and has not directly or indirectly colluded, conspired, connived, or agreed with any bidder or anyone else to put in a sham bid, or that anyone shall refrain from bidding; that the bidder has not in any manner, directly or indirectly, sought by agreement, communication, or conference with anyone to fix the bid price of the bidder or any other bidder, or to fix any overhead, profit, or cost element of the bid price, or of that of any other bidder, or to secure any advantage against the public body awarding the contract of anyone interested in the proposed contract; that all statements contained in the bid are true; and, further, that the bidder has not, directly or indirectly, submitted his or her bid price or any breakdown thereof, or the contents thereof, or divulged information or data relative thereto, or paid, and will not pay, any fee to any corporation, partnership, company association, organization, bid depository, or to any member or agent thereof to effectuate a collusive or sham bid.

I declare under penalty of perjury under the laws of the State of California that the foregoing is true and correct.

Date: _____

BIDDER:

By: _____

PUBLIC CONTRACT CODE

PUBLIC CONTRACT SECTION 10285.1 STATEMENT

In conformance with Public Contract Code Section 10285.1 (Chapter 376, Stats. 1985), the bidder hereby declares under penalty of perjury under the laws of the State of California that the bidder **has** ____, **has not** ____ been convicted within the preceding three years of any offenses referred to in that section, including any charge of fraud, bribery, collusion, conspiracy, or any other act in violation of any state or Federal antitrust law in connection with the bidding upon, award of, or performance of, any public works contract, as defined in Public Contract Code Section 1101, with any public entity, as defined in Public Contract Code Section 1100, including the Regents of the University of California or the Trustees of the California State University. The term "bidder" is understood to include any partner, member, officer, director, responsible managing officer, or responsible managing employee thereof, as referred to in Section 10285.1.

Note: The bidder must place a checkmark after "has" or "has not" in one of the blank spaces provided. The above Statement is part of the Bid Form. Signing this Bid Form on the signature portion thereof shall also constitute signature of this Statement. Bidders are cautioned that making a false certification may subject the certifier to criminal prosecution.

PUBLIC CONTRACT CODE SECTION 10162 QUESTIONNAIRE

In conformance with Public Contract Code Section 10162, the Bidder shall complete, under penalty of perjury, the following questionnaire:

Has the bidder, any officer of the bidder, or any employee of the bidder who has a proprietary interest in the bidder, ever been disqualified, removed, or otherwise prevented from bidding on, or completing a federal, state, or local government project because of a violation of law or a safety regulation?

Yes

No

If the answer is yes, explain the circumstances in the following space.

PUBLIC CONTRACT CODE 10232 STATEMENT

In conformance with Public Contract Code Section 10232, the Contractor, hereby states under penalty of perjury, that no more than one final unappealable finding of contempt of court by a federal court has been issued against the Contractor within the immediately preceding two-year period because of the Contractor's failure to comply with an order of a federal court which orders the Contractor to comply with an order of the National Labor Relations Board.

Note: The above Statement and Questionnaire are part of the Bid Form. Signing this Bid Form on the signature portion thereof shall also constitute signature of this Statement and Questionnaire. Bidders are cautioned that making a false certification may subject the certifier to criminal prosecution.

Signature of Contractor

COUNTY SPECIAL PROVISIONS

COUNTY OF NEVADA
STATE OF CALIFORNIA

SPECIAL PROVISIONS

For

2023 Road Rehabilitation Project

County Project No. 450011

The work embraced herein shall be done in accordance with the Project Plans, the Standard Plans and Standard Specifications dated 2018 of the California Department of Transportation, the Nevada County Road Standards and Nevada County Standard Road Drawings, and these Special Provisions.

Some sections of the Caltrans Standard Specifications are superseded by these County Special Provisions. While the County Special Provisions may appear to be similar to the Caltrans 2018 Standard Specifications in some respects, they are not the same. Bidders and Contractors are advised to read these County Special Provisions carefully, and to not assume that provisions that are similar to Caltrans provisions are actually the same. It is the responsibility of all Bidders to read and understand the County Special Provisions before submitting a Bid.

DIVISION I GENERAL PROVISIONS

SECTION 1 GENERAL

Conform to Section 1, "General" of the Standard Specifications, and these Special Provisions.

The work embraced herein shall be done in accordance with the State of California Standard Specifications, Revised Standard Specifications, Standard Plans and Revised Standard Plans, dated 2018, consistent with the County Standard Form Contract and in accordance with the following Special Provisions.

Wherever these Provisions require conforming to the Standard Specifications it must be interpreted to be conforming to the Standard Specifications and Revised Standard Specifications. Conforming to the Standard Specifications and Revised Standard Specifications is required unless specifically excluded or revised.

In case of conflict between the Standard Specifications or Standard Plans and these Special Provisions, the Special Provisions shall take precedence over and be used in lieu of such conflicting portions.

Wherever in the Standard Specifications, Special Provisions, Invitation to Bid, Instructions to Bidders, Bid Form, Contract, or other Contract documents the following terms are used, the intent and meaning shall be interpreted as follows:

STATE OR COUNTY OR STATE OF CALIFORNIA County of Nevada

DEPARTMENT OR DEPARTMENT OF PUBLIC WORKS County of Nevada
Department of Public Works

DIRECTOR OR DIRECTOR OF PUBLIC WORKS Board of Supervisors
County of Nevada

ENGINEER OR CHIEF ENGINEER	Director of the Department of Public Works County of Nevada acting either directly or through properly authorized agent and consultants
NOTICE TO BIDDERS NOTICE TO CONTRACTORS	INVITATION TO BID
REVISED STANDARD SPECIFICATIONS	New or revised standard specifications. These specifications are available at the following website: https://dot.ca.gov/programs/design/ccs- standard-plans-and-standard-specifications and as stated in Section 2-1.06B of the Standard Specifications.

SECTION 2 BIDDING

Conform to Section 2, "Bidding", of the Standard Specifications, and these Special Provisions.

The Bidder's attention is directed to the bidding documents preceding these Special Provisions, and the Standard Form Contract following these Special Provisions.

2-1.01 GENERAL

Bidding shall conform to Section 2, "Bidding", of the Standard Specifications, and these Special Provisions.

The bidder's bond shall conform to the bond form in the Bid Book for the project and shall be properly filled out and executed. The bidder's bond form included in that book may be used.

In conformance with Public Contract Code Section 7106, a Non-collusion Affidavit is included in the Bid Book. Signing the Bid Book shall also constitute signature of the Non-collusion Affidavit.

The contractor, subrecipient or subcontractor shall not discriminate on the basis of race, color, national origin, or sex in the performance of this contract. The contractor shall carry out applicable requirements of Title 49 CFR (Code of Federal Regulations) part 26 in the award and administration of US DOT assisted contracts. Failure by the contractor to carry out these requirements is a material breach of this contract, which may result in the termination of this contract or such other remedy, as the recipient deems appropriate. Each subcontract signed by the bidder must include this assurance.

SECTION 3 CONTRACT AWARD AND EXECUTION

3-1.01 GENERAL

The bidder's attention is directed to the provisions of Section 3, "Contract Award and Execution", of the Standard Specifications and these Special Provisions for the requirements and conditions concerning the award and execution of the contract.

Bid protests are to be delivered to the following address:

Nevada County Purchasing Division
Eric Rood Administrative Center
950 Maidu Avenue
Nevada City, CA 95959

The contract shall be executed by the successful bidder and shall be returned, together with the contract bonds and insurance, to the Agency so that it is received within **10 days**, not including

Saturdays, Sundays, and legal holidays, after the bidder has received the contract for execution. Failure to do so shall be just cause for forfeiture of the bid guaranty. The executed contract documents shall be delivered to the following address:

County of Nevada
Department of Public Works
950 Maidu Avenue 1st Floor, Suite 170
Nevada City, CA 95959

3-1.04 CONTRACT AWARD

Conform to 3-1.04, "Contract Award", of the Standard Specifications, and these Special Provisions.

The right is reserved to reject any and all bids.

If the Agency awards the contract, the award is made to the lowest responsible and responsive bidder.

3-1.05 CONTRACT BONDS (PUB CONT CODE §§ 10221 AND 10222)

Conform to Section 3-1.05, "Contract Bonds (Pub Cont Code §§ 10221 and 10222)", of the Standard Specifications, and these Special Provisions.

The successful bidder must furnish 2 bonds:

1. Payment bond to secure the claim payments of laborers, workers, mechanics, or materialmen providing goods, labor, or services under the Contract. This bond must be equal to at least 100 percent of the total bid.
2. Performance bond to guarantee the faithful performance of the Contract. This bond must be equal to at least 100 percent of the total bid.

Signed contract and bonds are due within 30 days of Notice of Award.

Sureties on each of said bonds shall be satisfactory to the County Attorney.

Should any bond become insufficient, the Contractor shall renew the bond within ten (10) working days after receiving notice from the Engineer.

Should any Surety at any time be unsatisfactory to the County, notice will be given the Contractor to that effect. No further payments shall be deemed due or will be made under said agreement until a new Surety shall qualify and be accepted by the County.

Changes in said agreement of extensions of time, made pursuant to the agreement, shall in no way release the Contractor or Surety from its obligations. Notice of such changes or extensions shall be waived by the Surety.

Delete Section 3-1.08

Delete Section 3-1.11

SECTION 4 SCOPE OF WORK

4-1.03 WORK DESCRIPTION

Perform work as described in the Invitation to Bid.

4-1.05B WORK-CHARACTER CHANGES

Conform to Section 4-1.05B, "Work-Character Changes", of the Standard Specifications, and these Special Provisions.

SIGNIFICANT CHANGES IN THE CHARACTER OF WORK

1. The engineer reserves the right to make, in writing, at any time during the work, such changes

in quantities and such alterations in the work as are necessary to satisfactorily complete the project. Such changes in quantities and alterations shall not invalidate the contract nor release the surety, and the contractor agrees to perform the work as altered.

2. If the alterations or changes in quantities significantly change the character of the work under the contract, whether such alterations or changes are in themselves significant changes to the character of the work or by affecting other work cause such other work to become significantly different in character, an adjustment, excluding anticipated profit, will be made to the contract. The basis for the adjustment shall be agreed upon prior to the performance of the work. If a basis cannot be agreed upon, then an adjustment will be made either for or against the contractor in such amount as the engineer may determine to be fair and equitable.
3. If the alterations or changes in quantities do not significantly change the character of the work to be performed under the contract, the altered work will be paid for as provided elsewhere in the contract.
4. The term "significant change" shall be construed to apply only to the following circumstances:
 - When the character of the work as altered differs materially in kind or nature from that involved or included in the original proposed construction; or
 - When a major item of work, as defined elsewhere in the contract, is increased in excess of 125 percent or decreased below 75 percent of the original contract quantity. Any allowance for an increase in quantity shall apply only to that portion in excess of 125 percent of original contract item quantity, or in case of a decrease below 75 percent, to the actual amount of work performed.

4-1.06 DIFFERING SITE CONDITIONS (23 CFR 635.109)

The following shall be substituted for Section 4-1.06, "Differing Site Conditions (23 CFR 635.109)," of the Standard Specifications:

4-1.06A GENERAL

Not used

4-1.06B CONTRACTOR'S NOTIFICATION

Conform to Section 4-1.06B, "Contractor's Notification", of the Standard Specifications, and these Special Provisions.

During the progress of the work, if subsurface or latent physical conditions are encountered at the site differing materially from those indicated in the contract or if unknown physical conditions of an unusual nature, differing materially from those ordinarily encountered and generally recognized as inherent in the work provided for in the contract, are encountered at the site, the party discovering such conditions shall promptly notify the other party in writing of the specific differing conditions before the site is disturbed and before the affected work is performed.

No contract adjustment which results in a benefit to the contractor will be allowed unless the contractor has provided the required written notice.

No contract adjustment will be allowed under this clause for any effects caused on unchanged work.

4-1.06C ENGINEER'S INVESTIGATION AND DECISION

Upon written notification, the engineer will investigate the conditions, and if it is determined that the conditions materially differ and cause an increase or decrease in the cost or time required for the performance of any work under the contract, an adjustment, excluding anticipated profits, will be made and the contract modified in writing accordingly. The engineer will notify the contractor of the determination whether or not an adjustment of the contract is warranted.

The Contractor will be allowed 15 days from the notification of the Engineer's determination of

whether or not an adjustment of the contract is warranted, in which to file a notice of potential claim in conformance with the provisions of Section 5-1.43C, "Supplemental Potential Claim Record", of the Standard Specifications and as specified herein; otherwise the decision of the Engineer shall be deemed to have been accepted by the Contractor as correct. The notice of potential claim shall set forth in what respects the Contractor's position differs from the Engineer's determination and provide any additional information obtained by the Contractor, including but not limited to additional geotechnical data. The notice of potential claim shall be accompanied by the Contractor's certification that the following were made in preparation of the bid: a review of the contract, a review of the "Materials Information", a review of the log of test borings and other records of geotechnical data to the extent they were made available to bidders prior to the opening of bids, and an examination of the conditions above ground at the site. Supplementary information, obtained by the Contractor subsequent to the filing of the notice of potential claim, shall be submitted to the Engineer in an expeditious manner.

4-1.13 CLEANUP

Conform to Section 4-1.13, "Cleanup", of the Standard Specifications, and these Special Provisions.

Cleanup shall consist of removing and disposing of all construction materials in connection with work. All parts of the work shall be left in a neat presentable condition.

Full compensation for conforming to the requirements of this section shall be considered as included in the prices paid for the various contract items of work involved and no additional compensation will be allowed therefor.

SECTION 5 CONTROL OF WORK

5-1.02 CONTRACT COMPONENTS

Conform to Section 5-1.02, "Contract Components", of the Standard Specifications, and these Special Provisions.

A component in one Contract part applies as if appearing in each. The parts are complementary and describe and provide for a complete work.

In the case of ambiguity or conflict, the documents shall be given the following priority:

1. Governing ranking of Contract parts in descending order is:
 - 1.1. Contract
 - 1.2. Instructions to Bidders, including addendums
 - 1.3. Project Special Provisions
 - 1.4. Project plans
 - 1.5. Revised standard specifications
 - 1.6. Standard specifications
 - 1.7. Revised standard plans
 - 1.8. Standard plans
 - 1.9. Supplemental project information
 - 1.10. Nevada County Road Standards and Nevada County Standard Road Drawings
2. Written numbers and notes on a drawing govern over graphics
3. Detail drawing governs over a general drawing
4. Specific specification governs over a general specification
5. Specification in a section governs over a specification referenced by that section

If a discrepancy is found or confusion arises, submit an RFI.

5-1.13 SUBCONTRACTING

Conform to Section 5-1.13, "Subcontracting", of the Standard Specifications, and these Special Provisions.

No subcontract releases the Contractor from the contract or relieves the Contractor of their

responsibility for a subcontractor's work.

If the Contractor violates Pub Cont. Code § 4100 et seq., the County of Nevada may exercise the remedies provided under Pub Cont. Code § 4110. The County of Nevada may refer the violation to the Contractors State License Board as provided under Pub Cont. Code § 4111.

The Contractor shall perform work equaling at least 30 percent of the value of the original total bid with the Contractor's own employees and equipment owned or rented, with or without operators.

Each subcontract must comply with the contract.

Each subcontractor must have an active and valid State contractor's license with a classification appropriate for the work to be performed (Bus & Prof Code, § 7000 et seq.).

Submit copies of subcontracts upon request by the Engineer.

Before subcontracted work starts, submit a Subcontracting Request form.

Do not use a debarred contractor; a current list of debarred contractors is available at the Department of Industrial Relations' Website.

Upon request by the Engineer, immediately remove and not again use a subcontractor who fails to prosecute the work satisfactorily.

5-1.26 CONSTRUCTION SURVEYS

Section 5-1.26, "Construction surveys", is amended to read:

County will provide markings for digout locations, station markers, and markings indicating the start and stop locations of shoulder widening, AC dike, and surfacing treatments.

5-1.32 AREAS FOR USE

Conform to Section 5-1.32, "Areas for Use", of the Standard Specifications, and these Special Provisions.

The highway right-of-way shall be used only for purposes that are necessary to perform the required work. The Contractor shall not occupy the right-of-way, or allow others to occupy the right-of-way, for purposes which are not necessary to perform the required work except as provided below.

No area is available within the project area for the exclusive use of the Contractor. However, where available, temporary storage of equipment and materials on County Property may be arranged with the Engineer but space may be limited. Use of the Contractor's work areas and other County-owned property shall be at the Contractor's own risk, and the County shall not be held liable for any damage to, or loss of materials or equipment located within such areas.

The Contractor shall obtain encroachment permits prior to occupying County-owned parcels outside the contract limits. The required encroachment permits may be obtained from the Nevada County Department of Public Works. Fees apply for permit processing, but not inspection.

Residence trailers will not be allowed within the highway right-of-way, except that one office trailer may be placed in the County right-of-way at a location to be designated by the Engineer.

The Contractor shall remove all equipment, materials and rubbish from the work areas and other County-owned property which it occupies and shall leave the areas in a presentable condition.

The Contractor shall secure at its own expense any area required for plant sites, storage of equipment or materials or for other purposes if sufficient area is not available to it within the contract limits or at the sites designated on the plans outside the contract limits.

Personal vehicles of employees must not be parked on the traveled way or shoulders, including sections closed to traffic.

5-1.36C NONHIGHWAY FACILITIES

COORDINATION WITH PUBLIC UTILITIES

Prior to the Contractor beginning construction, public utilities may need to relocate their facilities to avoid conflicts with the new structural section.

The Contractor will have the project limits marked and give a minimum notice to the utility companies of five (5) working days and coordinate with the utility company's crews for their relocation of all other services and meter boxes not indicated on the plans but within the limits of the project.

Full compensation for conforming to the requirements of this section shall be considered as included in the prices paid for the various contract items of work involved and no additional compensation will be allowed therefor.

5-1.43 POTENTIAL CLAIMS AND DISPUTE RESOLUTION

Conform to Section 5-1.43, "Potential Claims and Dispute Resolution", of the Standard Specifications, and these Special Provisions.

Revisions to Section 5-1.43A dated 10-19-18 are deleted in their entirety.

SECTION 6 CONTROL OF MATERIALS

6-2 QUALITY ASSURANCE

6-2.01 GENERAL

Conform to Section 6-2, "Quality Assurance", of the Standard Specifications, and these Special Provisions.

The Local Agency uses a Quality Assurance Program (QAP) to ensure a material is produced to comply with the contract. The Local Agency may examine the records and reports of tests the prime contractor performs if they are available at the job site.

The contractor may examine the records and reports of the tests the Agency performs if they are available at job site.

Schedule work to allow time for QAP.

6-2.03D PAYMENT

Full compensation for conforming to the requirements of Section 6-2, "Quality Assurance" and these Special Provisions shall be considered as included in the prices paid for the various contract items of work involved and no additional compensation will be allowed therefor.

SECTION 7 LEGAL RELATIONS AND RESPONSIBILITY TO THE PUBLIC

Conform to Section 7, "Legal Relations and Responsibility to the Public" of the Standard Specifications, and these Special Provisions.

Revisions to Section 7-1.02K(3) dated 10-19-18 are deleted in their entirety.

7-1.02I(2) NONDISCRIMINATION

Conform to Section 7-1.02I(2), "Nondiscrimination", of the Standard Specifications, and these Special Provisions.

Attention is directed to the following Notice that is required by Chapter 5 of Division 4 of Title 2, California Code of Regulations.

NOTICE OF REQUIREMENT FOR NONDISCRIMINATION PROGRAM (GOV. CODE, SECTION 12990)

Your attention is called to the "Nondiscrimination Clause", set forth in Section 7-1.02I(2), "Nondiscrimination", of the Standard Specifications, which is applicable to all nonexempt state contracts and subcontracts and to the "Standard California Nondiscrimination Construction Contract Specifications" set forth therein. The Specifications are applicable to all nonexempt state construction contracts and subcontracts of \$5,000 or more.

7-1.02K(2) WAGES

PREVAILING WAGE

Conform to Section 7-1.02K (2), "Wages", of the Standard Specifications, and these Special Provisions.

The general prevailing wage rates determined by the Director of Industrial Relations, for the county or counties in which the work is to be done, are available from the California Department of Industrial Relations' (CA DIR) website at <http://www.dir.ca.gov>. These wage rates are not included in the Bid Form and Contract for the project. Changes, if any, to the general prevailing wage rates will be available at the same location.

Attention is directed to Section 7-1.02K (3), "Certified Payroll Records (Labor Code 1776)", of the Standard Specifications. In addition to the specification, effective January 1, 2016, all contractors, and subcontractors are required to submit Electronic Certified Payroll through the CA DIR website's 'Electronic Certified Payroll Reporting System'. Contractors shall submit copies of the Electronic Certified Payroll directly to the County in addition to the CA DIR requirement.

7-1.04 PUBLIC SAFETY

Conform to Sections 7-1.04, "Public Safety", and 12-4.02, "Traffic Control Systems", of the Standard Specifications, and these Special Provisions.

Install temporary railing (Type K) between any lane carrying public traffic and any excavation, obstacle, or storage area when the following conditions exist:

1. Excavations. --Any excavation where near edge of the excavation is within 12-feet from the edge of the open traffic lane, except:
 - a. Excavations covered with sheet steel or concrete covers of adequate thickness to prevent accidental entry by traffic or the public.
 - b. Excavations less than 0.15 feet deep.
 - c. Excavations in side slopes where the slope is steeper than 4:1.
 - d. Excavations protected by barrier or railing.
2. Temporarily Unprotected Permanent Obstacles.--Whenever the work includes the installation of a fixed obstacle together with a protective system, such as a sign structure together with protective railing and the Contractor elects to install the obstacle prior to installing the protective system; or whenever the Contractor, for its convenience and with permission of the Engineer, removes a portion of an existing protective railing at an obstacle and does not replace such railing complete in place during the same day.
3. Storage Areas. --Whenever material or equipment is stored within 12 feet of the lane and such storage is not otherwise prohibited by the specifications.

When traffic cones or delineators are used to delineate a temporary edge of traffic lane, the line of cones or delineators shall be considered to be the edge of traffic lane, however, the Contractor shall not reduce the width of an existing lane to less than 10 feet without written approval from the Engineer. The lane closure provisions of this section shall not apply if the work area is protected by permanent or temporary railing or barrier.

When work is not in progress on a trench or other excavation that required a lane closure, the traffic cones or portable delineators used for the lane closure shall be placed off of and adjacent to the

edge of the traveled way. The spacing of the cones or delineators shall be not more than the spacing used for the lane closure.

Full compensation for conforming to the provisions in this section "Public Safety", including furnishing and installing temporary railing (Type K) and temporary crash cushion modules, shall be considered as included in the contract prices paid for the various items of work involved and no additional compensation will be allowed therefor.

7-1.06 INSURANCE

Section 7-1.06C shall be modified to increase the Employer's Liability Insurance to not less than:

1. \$2,000,000 for each accident for bodily injury by accident
2. \$2,000,000 policy limit for bodily injury by disease
3. \$2,000,000 for each employee for bodily injury by disease

Section 7-1.06D(2) shall be modified to require not less than \$2,000,000 for each occurrence

Section 7-1.06E shall be modified to require a minimum of \$2,000,000 automobile liability insurance

7-1.11E PAYMENT

Full compensation for conforming to the requirements of Section 7, "Legal Relations and Responsibility to the Public" and these Special Provisions shall be considered as included in the prices paid for the various contract items of work involved and no additional compensation will be allowed therefor.

SECTION 8 PROSECUTION AND PROGRESS

8-1.02 SCHEDULE

PROGRESS SCHEDULE

A progress schedule shall be submitted to the Engineer in accordance with Section 8-1.02, "Schedule", of the Standard Specifications, and these Special Provisions. The schedule shall be prepared using the critical path method (CPM) format.

Retention

The Department will retain an amount equal to 5 percent of the estimated value of the work performed during each estimate period in which the Contractor fails to submit an acceptable schedule conforming to the requirements of these provisions as determined by the Engineer. Schedule retentions will be released for payment on the next monthly estimate for partial payment following the date that acceptable schedules are submitted to the Engineer or as otherwise specified herein. Upon completion of all contract work and submittal of the final update schedule and certification, any remaining retained funds associated with this section, "Progress Schedule", will be released for payment. Retentions held in conformance with this section shall be in addition to other retentions provided for in the contract. No interest will be due the Contractor on retention amounts.

8-1.02D(10) PAYMENT

Payment for the required schedules and software is included in the payment for the bid items involved.

8-1.04 START OF JOB SITE ACTIVITIES

Conform to Section 8-1.04, "Start of Job Site Activities", Section 8-1.05, "Time", and Section 8-1.10, "Liquidated Damages", of the Standard Specifications, and these Special Provisions.

County shall not be obligated to accept or to pay for any work furnished by the Contractor prior

to delivery of notice to proceed whether County has knowledge of the furnishing of such work.

8-1.04B STANDARD START

Section 8-1.04B, "Standard Start", is deleted in its entirety.

8-1.05 TIME

Construction activity is limited to between 7 a.m. and 7 p.m. Monday through Friday, and between 8 a.m. and 6 p.m. on Saturday. No work is permitted on Sunday.

8-1.06 SUSPENSIONS

Conform to Section 8-1.06, "Suspensions", of the Standard Specifications, and these Special Provisions.

SUSPENSIONS OF WORK ORDERED BY THE ENGINEER

1. If the performance of all or any portion of the work is suspended or delayed by the engineer in writing for an unreasonable period of time (not originally anticipated, customary, or inherent to the construction industry) and the contractor believes that additional compensation and/or contract time is due as a result of such suspension or delay, the contractor shall submit to the engineer in writing a request for adjustment within 7 calendar days of receipt of the notice to resume work. The request shall set forth the reasons and support for such adjustment.
2. Upon receipt, the engineer will evaluate the contractor's request. If the engineer agrees that the cost and/or time required for the performance of the contract has increased as a result of such suspension and the suspension was caused by conditions beyond the control of and not the fault of the contractor, its suppliers, or subcontractors at any approved tier, and not caused by weather, the engineer will make an adjustment (excluding profit) and modify the contract in writing accordingly. The contractor will be notified of the engineer's determination whether or not an adjustment of the contract is warranted.
3. No contract adjustment will be allowed unless the contractor has submitted the request for adjustment within the time prescribed.
4. No contract adjustment will be allowed under this clause to the extent that performance would have been suspended or delayed by any other cause, or for which an adjustment is provided or excluded under any other term or condition of this contract.

SECTION 9 PAYMENT

9-1.03 PAYMENT SCOPE

PROMPT PAYMENT FROM THE AGENCY TO THE CONTRACTORS

The Agency shall make any progress payment within 30 days after receipt of an undisputed and properly submitted payment request from a contractor on a construction contract. If the Agency fails to pay promptly, the Agency shall pay interest to the contractor, which accrues at the rate of 10 percent per annum on the principal amount of a money judgment remaining unsatisfied. Upon receipt of a payment request, the Agency shall act in accordance with both of the following:

1. Each payment request shall be reviewed by the Agency as soon as practicable after receipt for the purpose of determining that it is a proper payment request.
2. Any payment request determined not to be a proper payment request suitable for payment shall be returned to the contractor as soon as practicable, but not later than seven (7) days, after receipt. A request returned pursuant to this paragraph shall be accompanied by a document setting forth in writing the reasons why the payment request is not proper.

PROMPT PAYMENT OF WITHHELD FUNDS TO SUBCONTRACTORS

The agency may hold retainage from the prime contractor and shall make prompt and regular

incremental acceptances of portions, as determined by the agency, of the contract work, and pay retainage to the prime contractor based on these acceptances. The prime contractor, or subcontractor, shall return all monies withheld in retention from a subcontractor within seven (7) days after receiving payment for work satisfactorily completed and accepted including incremental acceptances of portions of the contract work by the agency, unless as agreed to in writing by the prime contractor and subcontractor, pursuant to Section 7108.5 of the Business and Professions Code. Any violation of this provision shall subject the violating prime contractor or subcontractor to the penalties, sanctions and other remedies specified in Section this code. These requirements shall not be construed to limit or impair any contractual, administrative, or judicial remedies otherwise available to the prime contractor or subcontractor in the event of a dispute involving late payment or nonpayment by the prime contractor, deficient subcontract performance, or noncompliance by a subcontractor.

9-1.16 PROGRESS PAYMENTS

Conform to Section 9-1.16, "Progress Payments", of the Standard Specifications, and these Special Provisions.

9-1.16D MOBILIZATION

Conform to Section 9-1.16D, "Mobilization", of the Standard Specifications, and these Special Provisions.

In addition, payment shall be as follows:

Full compensation for project mobilization shall be considered as included in the contract prices paid for the various items of work involved and no additional compensation will be allowed.

9-1.16F RETENTIONS

Section 9-1.16F, "Retentions", shall be replaced with the following:

Pursuant to Public Contract Code §7201, the County shall retain **five percent (5%)** of Progress Payments as part of security for the fulfillment of the contract by the Contractor, and shall monthly pay to the Contractor, while carrying on the work, the balance not retained as aforesaid, after deducting therefrom all previous payments and all sums to be kept or retained under the provision of the contract. The County will release retention proceeds after the "Date of Completion" in accordance with California Civil Code §3260(c). No such estimate or payment shall be required to be made when, in the judgment of the Engineer, the work is not proceeding in accordance with the provisions of the contract.

For the purpose of making partial payments pursuant to Section 9-1.16, "Progress Payments", of the Standard Specifications, the amount set forth for the contract items of work hereinafter listed shall be deemed to be the maximum value of the contract item of work, which will be recognized for progress payment purposes.

Clearing and Grubbing 100%

After acceptance of the contract pursuant to the provisions in Section 5-1.46, "Final Inspection and Contract Acceptance", of the Standard Specifications, the amount, if any, payable for a contract item of work in excess of the maximum value for progress payment purposes hereinabove listed for the item, will be included for payment in the first estimate made after acceptance of the contract.

No partial payment will be made for any materials on hand which are furnished but not incorporated in the work.

In determining the partial payments to be made to the Contractor, only the following listed materials will be considered for inclusion in the payment as materials furnished but not incorporated in the work: None

9-1.17 PAYMENT AFTER CONTRACT ACCEPTANCE

Conform to Section 9-1.17, "Payment After Contract Acceptance", of the Standard Specifications, and these Special Provisions.

PROMPT PROGRESS PAYMENT TO SUBCONTRACTORS

A prime contractor or subcontractor shall pay any subcontractor not later than 7 days of receipt of each progress payment in accordance with the provisions of Section 7108.5 of the California Business and Professions Code concerning prompt payment to subcontractors. The 7 days is applicable unless a longer period is agreed to in writing. Any delay or postponement of payment over 30 days may take place only for good cause and with the agency's prior written approval. Any violation of Section 7108.5 shall subject the violating contractor or subcontractor to the penalties, sanction, and other remedies of that section. This requirement shall not be construed to limit or impair any contractual, administrative, or judicial remedies otherwise available to the contractor or subcontractor in the event of a dispute involving late payment or nonpayment by the prime contractor, deficient subcontract performance, or noncompliance by a subcontractor.

9-1.17C PROPOSED FINAL ESTIMATE

Conform to Section 9-1.17C, "Proposed Final Estimate", of the Standard Specifications, and these Special Provisions.

The third paragraph is deleted in its entirety.

9-1.22 ARBITRATION

Conform to Section 9-1.22, "Arbitration", of the Standard Specifications, and these Special Provisions.

Effective January 1, 2017, Public Contract Code §9204, as enacted by AB 626, establishes a claim resolution process required for public works projects. In the event of any conflict between the provisions of Article XXI and Public Contract Code §9204, the provisions of the Public Contract Code shall prevail. The entire section can be found at the following link:

https://leginfo.legislature.ca.gov/faces/codes_displayText.xhtml?lawCode=PCC&division=2.&title=&part=1.&chapter=9.&article

DIVISION II GENERAL CONSTRUCTION

SECTION 10 GENERAL

10-1.02D TRAFFIC STRIPES, PAVEMENT MARKINGS, AND PAVEMENT MARKERS

Conform to Section 10-1.02D, "Traffic Stripes, Pavement Markings, and Pavement Markers", of the Standard Specifications, the provisions of Article XVIII, "Order of Work", of the Contract, and these Special Provisions.

Upon completion of the Contractor's daily operations which obliterate pavement delineation (lane lines, either pavement markers or painted lane lines or both), such pavement delineation shall be replaced by temporary delineation. Temporary delineation shall consist of reflective traffic line tape applied in pieces not less than four (4) inches long nor less than four (4) inches wide spaced no more than twelve (12) feet apart on curves nor more than twenty-four (24) feet apart on tangents. Reflective traffic line tape shall be applied in accordance with the manufacturer's instructions. Temporary delineation shall be the same color as the permanent delineation. Temporary delineation shall be updated and maintained daily. Temporary pavement markers shall be removed prior to placement of road surfacing materials.

Full compensation for temporary delineation shall be considered as included in the prices paid for the contract items of work that obliterated the existing delineation and no separate payment will be made therefor.

10-5 DUST CONTROL

Conform to Section 10-5 "Dust Control", of the Standard Specifications, and these Special Provisions.

Dust control shall be provided by the Contractor on a daily basis including weekends and holidays. Water shall be applied as specified in Section 10-6, "Watering", of the Standard specifications and these Special Provisions.

The application of water shall be subject to control by the Engineer at all times and shall be applied in the amounts at the locations and at the times designated by the Engineer.

PAYMENT

Full compensation for furnishing all labor, materials, tools, equipment, and incidentals for completing all the work involved in Dust Control and Watering shall be considered as included in the contract prices paid for the various items of work involved in this project and no additional compensation will be allowed therefor.

SECTION 12 TEMPORARY TRAFFIC CONTROL

12-1 GENERAL

Conform to Sections 7-1.04, "Public Safety", and 12-4.02, "Traffic Control Systems", of the Standard Specifications, and these Special Provisions.

The Contractor shall prepare and submit to the Engineer a Traffic Control Plan in conformance with these requirements as the first order of work. Control Plans shall be developed and submitted by a qualified person, reviewed, and approved by the Engineer, and implemented by the Contractor prior to the beginning of work.

Road closures shall not be allowed. Contractor shall maintain at least one lane of travel for alternating traffic at all times, with a maximum wait time of 20 minutes.

The Engineer approved Traffic Control Plan must be submitted to Caltrans for review when requesting your encroachment permit rider for work in the State right-of-way.

Contractor shall use appropriately sized equipment to facilitate operations on one lane at a time. The public shall not be detained longer than 15 minutes per delay.

As the work progresses, it may be necessary to amend or supplement this Plan. All such modifications shall be as approved or otherwise directed by the Engineer. Access to street intersections, public and private parking lots, commercial premises, residences, and other public and private properties must be maintained. **At least 72 hours in advance of starting any work that may affect access to private properties, the Contractor shall provide written notice to property owners.** Contractor shall submit notice of work to the engineer for approval prior to posting notices. Access to and from commercial and residential driveways and parking lots may be restricted when performing items of work which cannot be accomplished without access restriction. The road shall be open, and access shall be provided during non-working hours.

At least 72 hours in advance of starting work in an section, the Contractor shall provide changeable message sign (CMS) boards to alert residents of potential delays. Contractor shall submit message to be displayed to the Engineer for approval prior to posting. Message will be approved or amended within 48 hours of submission.

All traffic control shall conform to the minimum standards as set forth in the latest edition of the Manual of Traffic Controls for Construction and Maintenance Work Zones, published by the California Department of Transportation as supplemented by the Standard Specifications and these provisions and as directed by the Engineer. **No work will begin prior to approval of the Traffic Control Plan**

The provisions of the Control Plans shall identify various segments of the work site by areas of control requirements and should be used in conjunction with other requirements of the Plans and

Specifications. The Contractor is not restricted to operations within any one (1) area or combination of areas and may elect to work more than one (1) area concurrently pursuant to other requirements of the Plans and Special Provisions. The Control Plans should be considered as a minimum requirement during the Contractor's active performance of items of work. Other or additional requirements may be necessary depending upon the character of the work involved and/or times when construction activity is not in progress. At a minimum, the Traffic Control Plan shall consist of the following:

- a. Placement of the traffic controls as described in Section 12-4.
- b. The base material of construction area signs shall not be plywood.

12-1.04 PAYMENT

Payment for preparing, submitting, amending, and supplementing the Traffic Control Plan and for furnishing, installing and maintaining all construction area traffic controls including all signs, CMS boards, lights, flaggers, pilot vehicles, temporary railing, barricades and other warning and safety devices as described in the Traffic Control Plan, the Standard Specifications, these Special Provisions, and as directed by the Engineer is included in the payment for the bid items involved.

12-3.02B MATERIALS

Conform to Section 12-3.02B, "Materials", of the Standard Specifications, and these Special Provisions.

Retroreflective traffic cones when used during the hours of darkness shall comply with Section 12-3.02B, "Materials", of the Standard Specifications, except that the sleeves shall be seven (7) inches long.

12-4 MAINTAINING TRAFFIC

Conform to Section 12-4, "Maintaining Traffic", of the Standard Specifications, and these Special Provisions.

Whenever vehicles or equipment are parked on the shoulder within six (6) feet of a traffic lane, the shoulder area shall be closed with fluorescent traffic cones or portable delineators placed on a taper in advance of the parked vehicles or equipment and along the edge of the pavement at twenty-five (25) foot intervals to a point not less than twenty-five (25) feet past the last vehicle or piece of equipment. A minimum of nine (9) cones or portable delineators shall be used for the taper. A C23 (Road Work Ahead) or C24 (Shoulder Work Ahead) sign shall be mounted on a telescoping flag tree with flags. The flag tree shall be placed where directed by the Engineer.

A minimum of one traffic lane, not less than 10-feet wide, shall be open for use by public traffic. When construction operations are not actively in progress, not less than two such lanes shall be open to public traffic.

As directed by the Engineer, when possible, the full width of the traveled way shall be open for use by public traffic on Saturdays, Sundays and designated legal holidays, after 3:00 p.m. on Fridays, and the day preceding designated legal holidays and when construction operations are not actively in progress.

12-4.02 TRAFFIC CONTROL SYSTEMS

Conform to Sections 12, "Temporary Traffic Control", and 7-1.04, "Public Safety", of the Standard Specifications, and these Special Provisions.

When lane closures are made for work periods only, at the end of each work period all components of the traffic control system, except portable delineators placed along open trenches or excavation adjacent to the traveled way, shall be removed from the traveled way and shoulder. If the Contractor so elects, said components may be stored at selected central locations, approved by the Engineer, within the limits of the County Road right-of-way.

12-4.02C(2) LANE CLOSURE SYSTEM

TRAFFIC CONTROL SYSTEM FOR LANE CLOSURE

Conform to Sections 12, "Temporary Traffic Control" and 12-4, "Maintaining Traffic", of the Standard Specifications and these Special Provisions.

The provisions of this section do not relieve the Contractor from its responsibility to provide such additional devices or take such measures as may be necessary to conform to Section 7-1.04, "Public Safety", of the Standard Specifications.

During the hours of darkness, as defined in Division 1, Section 280, of the Vehicle Code, portable signs shall be, at the option of the Contractor, either illuminated signs conforming to Section 12-3.11B(3), "Portable signs", of the Standard Specifications, or Reflexite vinyl microprism reflective sheeting signs, or 3M high intensity reflectorized sheeting on aluminum substrate signs, or Seibulite Brand Ultralite Grade Series encapsulated lens retroreflective sheeting signs, or equal.

If any component of the traffic control system is displaced or ceases to operate or function as specified, from any cause, during the progress of the work, the Contractor shall immediately repair the component to its original condition or replace the component and shall restore the component to its original location.

When lane closures are made for work periods only, at the end of each work period, all components of the traffic control system, except portable delineators placed along open trenches or excavation adjacent to the traveled way shall be removed from the traveled way and shoulder. If the Contractor so elects, said components may be stored at selected central locations, approved by the Engineer, within the limits of the County Road right-of-way.

12-4.02D PAYMENT

Section 12-4.02D, "Payment", is amended to read:

Full compensation for providing the traffic control system including costs for all flaggers, pilot vehicles, signs and lights shall be considered as included in the lump sum price paid under traffic control and no additional compensation will be allowed therefor.

The Department pays for change order work for a traffic control system by force account for increased traffic control, as provided in Article VI of the Contract, and uses a force account analysis for decreased traffic control.

12-6 TEMPORARY PAVEMENT DELINEATION

12-6.01 GENERAL

Conform to Section 5, "Control of Work", of the Standard Specifications, and these Special Provisions.

Upon completion of the Contractor's daily operations which obliterate pavement delineation (lane lines: either pavement markers or painted lane lines or both), such pavement delineation shall be replaced by temporary delineation. Temporary delineation shall consist of reflective traffic line tape applied in pieces not less than four (4) inches long nor less than four (4) inches wide spaced no more than twelve (12) feet apart on curves, nor more than twenty-four (24) feet apart on tangents. Reflective traffic line tape shall be applied in accordance with the manufacturer's instructions. Temporary delineation shall be the same color as the permanent delineation. Temporary delineation shall be updated and maintained daily. Temporary pavement markers shall be removed prior to placement of road surfacing materials

Full compensation for temporary delineation shall be considered as included in the prices paid for

the contract items of work that obliterated the existing delineation and no separate payment will be made therefor.

SECTION 13 WATER POLLUTION CONTROL

Conform to Section 13, "Water Pollution Control", of the Standard Specifications, and these Special Provisions.

13-1.01 GENERAL

13-1.01A SUMMARY

Water pollution control work applies to project where work activities result in less than 1 acre of soil disturbance and projects that qualify for an erosivity waiver. Manage work activities to reduce the discharge of pollutants to surface waters, groundwater, or municipal separate storm sewer systems including contract work item for Prepare Water Pollution Control Program.

Do not begin work until the WPCP is accepted.

Your Engineer approved Water Pollution Control Plan must be submitted to Caltrans for approval when requesting your encroachment permit rider.

13-1.01C SUBMITTALS

Conform to Section 13-1.01C, "Submittals", of the Standard Specifications, and these Special Provisions.

13-1.01C(1) GENERAL

Within 10 calendar days, not including Saturdays, Sundays, and legal holidays, of receipt of the executed contract, start the following process for WPCP acceptance:

1. Submit 2 copies of the WPCP and allow 5 days for the Engineer's review. If revisions are required, the Engineer provides comments and specifies the date that the review stopped.
2. Change and resubmit the WPCP within 5 days of receipt of the Engineer's comments. The Engineer's review resumes when the complete WPCP is resubmitted.
3. When the Engineer accepts the WPCP, submit an electronic and 3 printed copies of the accepted WPCP.

If you operate construction support facilities, protect storm water systems or receiving waters from the discharge of potential pollutants by using water pollution control practices. Construction support facilities include:

1. Staging areas
2. Storage yards for equipment and materials
4. Mobile operations
5. Batch plants for PCC and HMA
6. Crushing plants for rock and aggregate
7. Other facilities installed for your convenience such as haul roads

For the Preparation Manual and other water pollution control references, go to the Department's "Construction Storm Water and Water Pollution Control" web site at: <https://dot.ca.gov/programs/construction/storm-water-and-water-pollution-control>

13-1.01D QUALITY ASSURANCE

13-1.01D(4) WATER POLLUTION CONTROL MANAGER

Conform to Section 13-1.01D(4), "Water Pollution Control Manager", of the Standard Specifications, and these Special Provisions.

13-1.01D(4)(a) GENERAL

The Contractor shall designate in writing a Water Pollution Control Manager (WPCM).

13-1.03 CONSTRUCTION

13-1.03C INSPECTIONS

Inspections shall conform to Section 13-1.03C, "Inspections", of the Standard Specifications, and these Special Provisions.

If the following occur, notify the Engineer within 6 hours:

1. You identify discharges into receiving waters or drainage systems causing or potentially causing pollution
2. The job receives a written notice or order from a regulatory agency

No later than 48 hours after the conclusion of a storm event resulting in a discharge, a nonstormwater discharge, or receiving the notice or order, submit:

1. Date, time, location, and nature of the activity, type of discharge and quantity, and the cause of the notice or order
2. Water pollution control practices used before the discharge, or before receiving the notice or order
3. Description of water pollution control practices and corrective actions taken to manage the discharge or cause of the notice.

13-2 WATER POLLUTION CONTROL PROGRAM

13-2.01 GENERAL

13-2.01A SUMMARY

Conform to Section 13-2.01A, "Summary", of the Standard Specifications, and these Special Provisions.

The work includes preparing a WPCP, obtaining WPCP acceptance, amending the WPCP, and reporting on water pollution control practices at the job site. The WPCP must comply with the Preparation Manual.

You may request, or the Engineer may order, changes to the water pollution control work. Changes may include addition of new water pollution control practices. Additional water pollution control work is change order work.

The WPCP must include water pollution control practices:

1. For storm water and non-stormwater from areas outside of the job site related to project work activities such as:
 - 1.1. Staging areas
 - 1.2. Storage yards
 - 1.3. Access roads
2. For activities or mobile operations related to contractor obtained NPDES Permits
3. Construction support facilities

The WPCP must include a copy of permits obtained by the County such as Fish & Game permits, US Army Corps of Engineers permits, RWQCB 401 Certifications, and RWQCB Waste Discharge Requirements for Aerially Deposited Lead Reuse. The County will provide copies of the permits to you before completion of the WPCP.

WPCP Amendments

You must amend the WPCP when:

1. Changes in work activities could affect the discharge of pollutants
2. Water pollution control practices are added by change order work
3. Water pollution control practices are added by your discretion

If you amend the WPCP, follow the same process specified for WPCP acceptance.

Retain a printed copy of the accepted WPCP at the job site.

WPCP Schedule

The WPCP schedule must:

1. Describe when work activities will be performed that could cause the discharge of pollutants in storm water
2. Describe water pollution control practices associated with each construction phase
3. Identify soil stabilization and sediment control practices for disturbed soil areas

13-2.03 CONSTRUCTION

IMPLEMENTATION REQUIREMENTS:

Monitor the National Weather Service Forecast Office on a daily basis. For forecasts, go to:

<https://www.weather.gov/forecastmaps>

Whenever you or the Engineer identifies a deficiency in the implementation of the accepted WPCP:

1. Correct the deficiency immediately, unless the Engineer authorizes an agreed date for correction
2. Correct the deficiency before precipitation occurs

If you fail to correct the deficiency by the agreed date or before the onset of precipitation, the County may correct the deficiency and deduct the cost of correcting the deficiency from payment.

If you fail to comply with "Water Pollution Control" of these Special Provisions, the Engineer will order a suspension of work until the project complies with the requirements of "Water Pollution Control" of these Special Provisions.

The Contractor's responsibility for WPCP implementation shall continue throughout any temporary suspension of work ordered in conformance with the provisions in Section 8-1.05, "Temporary Suspension of Work" of the Standard Specifications.

Install water pollution control practices within 15 days or before predicted precipitation, whichever occurs first except as required sooner as required elsewhere by these Special Provisions.

If actions for the Contractor's convenience disturb one or more acres, the Contractor must pay all costs and be responsible for all delays associated with complying with Order No. 2009-0009- DWQ, NPDES General Permit No. CAS000002) issued by the SWRCB for "Storm Water Discharges Associated with Construction and Land Disturbance Activities".

The General Permit is available at:

<https://www.waterboards.ca.gov>

Inspection

The Water Pollution Control Manager must oversee inspections for water pollution control practices identified in the WPCP:

1. Before a forecasted storm
2. After precipitation that causes site runoff
3. At 24-hour intervals during extended precipitation
4. On a predetermined schedule, a minimum of once a week

The Water Pollution Control Manager must oversee daily inspections of:

1. Storage areas for hazardous materials and wastes
2. Hazardous waste disposal and transporting activities
3. Hazardous material delivery and storage activities
4. Water pollution control practices specified under "Construction Site Management" of these Special Provisions

The Water Pollution Control Manager must use the Storm Water Site Inspection Report provided in the Preparation Manual.

The Water Pollution Control Manager must prepare BMP status reports that include the following:

1. Location and quantity of installed water pollution control practices
2. Location and quantity of disturbed soil for the active or inactive areas

Within 24 hours of finishing the weekly inspection, the Water Pollution Control Manager must submit:

1. Copy of the completed site inspection report
2. Copy of the BMP status report

13-2.04 PAYMENT

Conform to Section 13-2.04, "Payment", of the Standard Specifications, and these Special Provisions.

If you fail to comply with "Water Pollution Control" of these Special Provisions or fail to implement water pollution control practices during each estimate period, the County withholds 25 percent from progress payment.

Withholds for failure to perform water pollution control work are in addition to all other withholds provided for in the contract. The County returns performance failure withholds in the progress payment following the correction for noncompliance.

Water Pollution Control Program (WPCP) includes preparing the WPCP, obtaining WPCP acceptance, amending, and implementing the WPCP, and installation, maintenance, monitoring, and inspecting water pollution control practices at the job site, except for items listed separately in the bid list, as specified in the Standard Specifications and these Special Provisions, and as directed by the Engineer.

The County does not pay for implementation of water pollution control practices in areas outside the right of way not specifically provided for in the drawings or in the Special Provisions. The County does not pay for water pollution control practices installed at construction support facilities as included in other items of work and no separate payment will be made therefor.

The County does not share maintenance costs.

SECTION 14 ENVIRONMENTAL STEWARDSHIP

PROTECTION OF ARCHAEOLOGICAL ARTIFACTS

Attention is directed to Section 14-2.03, "Archaeological Resources," of the Standard Specifications.

In the event that archaeological artifacts or human remains are uncovered during construction activities, the Contractor shall stop work at that location and immediately notify the Engineer.

The Contractor shall dedicate any discovered artifacts, determined as "removable" by a qualified archaeologist, to the appropriate preservation center, or to the County of Nevada.

If buried cultural resources, such as chipped or ground stone, historic debris, building foundations, or human bone, are discovered during ground-disturbing activities, contractors shall stop work within 100 feet of the find.

Full compensation for conforming to the requirements of this section shall be considered as included in the prices paid for the various contract items of work involved and no additional compensation will be allowed therefor.

14-8.02 NOISE CONTROL

Conform to 14-8.02, "Noise Control", of the Standard Specifications, and these Special Provisions.

The noise level from the Contractor's operations, between the hours of 9:00 p.m. and 6:00 a.m. shall not exceed 86 dba at 50-feet. This requirement in no way relieves the Contractor from responsibility for complying with local ordinances regulating noise level.

Said noise level requirement shall apply to all equipment on the job or related to the job, including but not limited to trucks, transit mixers or transient equipment that may or may not be owned by the Contractor. The use of loud sound signals shall be avoided in favor of light warnings except those required by safety laws for the protection of personnel.

Operation of construction equipment or noise generating activities shall be limited to the daytime hours of 7:00 a.m. to 7:00 p.m. All internal combustion engines in use on site must be equipped with the original manufacturer's silencers or their aftermarket equivalents in good working order.

Full compensation for conforming to the requirements of this section shall be considered as included in the prices paid for the various contract items of work involved and no additional compensation will be allowed therefor.

DIVISION III EARTHWORK AND LANDSCAPE

SECTION 17 GENERAL

17-2 CLEARING AND GRUBBING

If minor clearing and grubbing is required to facilitate operations, conform to Section 17-2, "Clearing and Grubbing", of the Standard Specifications, and these Special Provisions.

All existing vegetation outside the areas to be cleared and grubbed shall be protected from injury or damage resulting from the Contractor's operations.

All activities controlled by the Contractor, except cleanup or other required work, shall be confined within the graded areas of the roadway.

Relocation of signs and mailboxes as required shall be included in clearing and grubbing.

It is the responsibility of the Contractor to verify trees and stumps that will be located within the clearing limits.

Nothing herein shall be construed as relieving the Contractor of its responsibility for final cleanup of the highway.

17-2.01 GENERAL

Conform to Section 17-2.01, "General", of the Standard Specifications, and these Special Provisions.

Check for low hanging tree limbs that may interfere with the passage of equipment. Trim trees as required to perform the work.

Coordinate tree trimming and tree removal with the Engineer. Call PG&E prior to trimming any trees within 10 feet of high voltage power lines or obstructing the operation of construction equipment.

Do not remove trees between February 15 to September 1 unless you have a qualified biologist conduct a bird survey before tree removal and there are no nesting birds found. Conform to Section 14-6.03, "Species Protection" of the Standard Specifications.

17-2.03 CONSTRUCTION

17-2.03A GENERAL

Replace the 4th paragraph of Section 17-2.03A, "General", with:

Clear and grub vegetation only within the designated areas of the roadway required for shoulder widening.

Clear and grub before performing earthwork in an area.

Do not injure standing trees, plants, and improvements shown to be protected.

17-2.03B CLEARING

Clearing is included under lump sum bid item "Clearing and Grubbing".

Clear all construction areas for shoulder widening of (1) all vegetation such as trees, logs, upturned stumps, roots of downed trees, brush, grass, and weeds and (2) other objectionable material including concrete, masonry, and debris.

Vegetation shall be cleared and grubbed only to the extent necessary. Unless directed by the Engineer, there shall be no trees removed.

All existing vegetation, outside the areas to be cleared and grubbed, shall be protected from injury or damage resulting from the Contractor's operations.

All activities controlled by the Contractor, except cleanup or other required work, shall be confined within the graded areas of the roadway.

Payment for all limb clearing shall be included in item "Clearing and Grubbing" no additional compensation shall be made.

17-2.03D Disposal of Materials

Any materials resulting from clearing and grubbing activities shall become the responsibility of the contractor to dispose of unless otherwise instructed by the engineer.

17-2.04 PAYMENT

Full compensation for all labor, materials, tools, and equipment for doing all work required under "Clearing and Grubbing", including removal and disposal of tree stumps, existing structures, existing culverts, removed fencing, relocated mailboxes, signs, and other items shall be considered included and no additional compensation will be allowed.

SECTION 19 EARTHWORK

19-11 DIG-OUT AND REPAIR

19-11.01 CONSTRUCTION

"Dig-out and repair" includes removal AND REPAIR of failed roadway structural section and subgrade preparation. Engineer will mark out areas of failed roadway surface for removal/repair.

Contractor will remove failed roadway surfacing to a depth of 3 inches, prepare and compact existing base/subbase, place 3 inches of 1/2-inch maximum, medium grade type A asphalt concrete into repair area, and compact to 95% RC. Prior to placement of asphalt concrete, contractor shall compact any loose subgrade material to 95% RC. HMA fibers are not required in the HMA patch material.

Contractor will complete repairs a minimum of five days before placement of the slurry-surfacing materials.

19-11.02 PAYMENT

The contract item price paid per square foot for "Dig-out and Repair" includes full compensation for furnishing all labor, materials, tools, equipment, and incidentals for doing all the work involved in dig-out and repair, complete in place, including developing and submitting mix designs, HMA, subgrade preparation, application of tackifier, traffic control, removal of failed roadway materials, tree roots, grinding of existing asphalt, placement of fog seal, placement of new materials, and compaction.

19-12 SHOULDER WIDENING

19-12.01 CONSTRUCTION

“Shoulder Widening” includes excavation of unsuitable material, compaction of subgrade to 95% RC, installation of ¾” class 2 AB per construction details before paving operations, and installation and compaction of ¾” class 2 AB backfill behind AC dike after dike installation. All fill must be compacted to 95% RC. Shoulder widening shall be completed as directed by the engineer. Shoulder widening shall conform to the provisions in Section 19 , “Earthwork” of the Standard Specifications and these Special Provisions.

Width and depth of ditches to be replaced with shoulder varies throughout the jobsite. Shoulders to be widened will run from edge of existing pavement to existing slope or a maximum of 4 ft from edge of existing roadway unless otherwise directed by the engineer. Excavation should be limited to the removal of unsuitable materials within ditches and shoulders to be widened.

19-12.02 PAYMENT

The contract item price paid per linear foot for “Shoulder Widening” includes full compensation for furnishing all labor, materials, tools, equipment, and incidentals for doing all the work involved in shoulder widening, complete in place, including subgrade preparation, traffic control, removal of unsuitable subgrade materials, excavation, placement of new materials, and compaction. Pavement to be placed on widened shoulders and Type A AC Dike shall be paid under their respective bid items.

SECTION 26 AGGREGATE BASES

26-1 GENERAL

Conform to section 26, “Aggregate Bases”, of the Standard Specifications and these Special Provisions.

26-2 SHOULDER BACKING

26-2.01 CONSTRUCTION

“Shoulder Backing” includes the placement of ¾” class 2 AB along the edge of the roadway after completion of paving operations. AB is to be placed out 2 feet wide from edge of new pavement or as directed by the Engineer and run even with the new top of pavement. All AB must be compacted 95% RC. Care should be taken to not damage freshly placed asphalt. Contractor is responsible for clean up of road way after installation of shoulder backing.

26-2.02 PAYMENT

The contract item price paid per cubic yard for “Shoulder Backing” includes full compensation for furnishing all labor, materials, tools, equipment, and incidentals for doing all the work involved in shoulder backing, complete in place, including preparation, traffic control, placement of new materials, and compaction. Shoulder backing is paid for by volume, the payment quantity is determined from the length of shoulder treated, 2 foot width, and 0.167” thickness.

DIVISION V SURFACING AND PAVEMENTS

SECTION 37 BITUMINOUS SEALS

37-1 GENERAL

Conform to section 37-1.01, “General;”, of the Standard Specifications and these Special Provisions.

Exact location of all pavement markings and striping shall be identified and recorded by the contractor prior to the placement of any road treatment.

The work shall consist of but not be limited to furnishing all labor, materials, equipment, and transportation for the application of crack sealing and Type II micro-surfacing the roadway.

Micro-surfacing shall not be placed on portions of the roadway where there is a high friction surface treatment. Protect high friction surface treatment areas from micro-surfacing materials or any damage during surface preparation, application, cleanup, striping or any other stage of operations

37-3 SLURRY SEAL AND MICRO-SURFACINGS

Conform to section 37-3, "Slurry Seal and Micro-Surfacings", of the Standard Specifications and these Special Provisions.

37-3.01C(4) SURFACE PREPARATION

In addition to the requirements of 37-3.01C(4) "Surface Preparation", surface preparation prior to micro-surfacing shall also include removal of any grass, weeds or other vegetation from the pavement, removal of any extensive grease spots or oil saturated surfaces by washing or lightly grinding the pavement, removal of any thermoplastic markings leaving behind a textured surface, removal of any pavement markers and residual adhesive, removal of any paint markings or striping that have substantial paint buildup, and any utility structures and castings such as manhole covers and valve boxes shall be appropriately covered for protection.

The pavement surface shall be dry and shall have been swept clean immediately prior to micro-surfacing.

37-3.01C(3) MIXING AND SPREADING EQUIPMENT

37-3.01C(3)(a) GENERAL

All equipment, attachments and accessories shall be in good working order and function as intended by the manufacturer, shall be free of fluid leaks, and shall be clean and free of unwanted materials and debris.

Sweepers shall meet applicable U.S. Environmental Protection Agency standards and shall have non-metallic bristles of the correct length that can be adjusted vertically to exert the proper downforce.

Provide enough mobile support units to allow continuous micro-surfacing operations.

37-3.01C(5)(d)(1) FINISHED SURFACES

Contractor shall make a minimum of 5 passes with a 5 to 8 ton rubber-pneumatic-tired roller as part of the finishing process, until the surface finish is smooth. The roller tire size, rating and pressures shall comply with manufacturer's recommendations, tire pressures shall be the same on all tires, and all tires shall have a smooth surface. Rolling shall not begin until the micro-surfacing is cool and stable and rollers shall travel at no more than 5 mph.

Micro-surfacing seams shall be straight and along the road centerline or edgelines.

37-3.03A(3) SUBMITTALS

At least 10 days before starting micro-surfacing, submit a mix design and a mix design report of laboratory tests performed for the micro-surfacing materials. A representative of the laboratory performing the mix design and tests must sign the report. The Engineer reviews and approves the submittal before you start micro-surfacing.

Do not substitute materials after the mix design is approved unless the substitute materials are laboratory-tested, and you submit a new mix design and report. Does not use substitute materials until the Engineer approves the mix design for those materials.

Submit a Certificate of Compliance with each MSE shipment as specified for asphaltic emulsion in Section 94-1.05, "Test Report," of the Standard Specifications.

37-3.03A(4) QUALITY ASSURANCE

37-3.03A(4)(a) GENERAL

Before micro-surfacing activities start, submit the name of a person authorized to communicate with the Engineer about days when unsuitable weather conditions prevent micro-surfacing. Temporary pavement markers shall be removed prior to placement of micro-surfacing material.

37-3.03B(5) MICRO-SURFACING MIX DESIGNS

Proportion limits for Water and Additives shall be amended to read: "No limit; must include 2- 3% latex additive."

Proportion limits for Mineral filler shall be amended to read: 1-5% of dry weight of aggregate.

The mix design report must include:

1. Test results used in the mix design
2. Based on the aggregate's dry weight, the proportions of:
 - 2.1. Aggregate
 - 2.2. Water, minimum and maximum
 - 2.3. Additives
 - a. Mineral filler, minimum and maximum
 - b. MSE residual asphalt content, minimum and maximum
3. Based on heating the mixture to 100 °F and mixing for 60 seconds, any recommended changes to the proportions of:
 - a. Water
 - b. Additives
 - c. Mineral filler

Do not recommend these changes when nighttime applications are specified or when atmospheric temperatures below 90 °F are forecast for daytime applications.

4. A comparison of each individual material's test results to its specified values. The Engineer accepts mix design reports prepared within the previous 12 months of this project's mix design report submittal if the test results are for the same materials.
5. The quantitative moisture effects on the aggregate's unit weight determined under ASTM C 29M.

37-3.03B(3) AGGREGATE

Aggregate must be free of:

- Vegetable matter
- Deleterious substances
- Clay lumps
- Oversized particles

37-3.03C(2) PROPORTIONING

A belt feeder with an adjustable cutoff gate must proportion aggregate. The gate opening height must be determinable.

For the aggregate belt feeder, the delivery rate for any individual check run must not deviate more than 2 percent from the average of the rates of 3 runs of at least 3 tons each.

Proportion MSE using a positive displacement pump.

For the emulsion pump, the delivery rate for any individual check run must not deviate more than 2 percent from the average of the rates of 3 runs of at least 300 gallons each.

37-3.03C(5)(c) MICRO-SURFACING PAVEMENT SURFACES

Type II micro-surfacing spread rate (application range) shall be amended to read: "15 +/- 1"

37-3.03D PAYMENT

Section 37-3.03D, "Payment", is amended to read:

The contract item price paid per square yard for "MICRO-SURFACING (TYPE II)" includes full compensation for furnishing all labor, materials, tools, equipment, and incidentals for doing all the work involved in micro-surfacing, complete in place, including developing and submitting mix designs, all other surface preparation, utility marking, and cleaning of pavement, as shown on the plans, as specified in the Standard Specifications and these Special Provisions and as directed by the Engineer.

If the Engineer determines a test strip unacceptable, the Department does not pay for the test strip:

- Materials
- Placement
- Removal, if ordered by the Engineer

37-6 CRACK TREATMENTS

Conform to section 37-6, "Crack Treatments", of the Standard Specifications and these Special Provisions.

37-6.04 PAYMENT

The payment quantity for crack treatment is the length measured in **feet** along the edge of each paved lane (LANE FOOT) parallel to the pavement's centerline. The payment for a lane includes crack treatment of the adjacent shoulder.

The contract item price paid per lane foot for crack treatment includes full compensation for furnishing all labor, materials, tools, equipment, and incidentals for doing all the work involved in crack treatment, complete in place as specified in the Standard Specifications.

SECTION 39 ASPHALT CONCRETE

39-1.01 GENERAL

Exact location of all pavement markings and striping shall be identified and recorded by the contractor prior to the placement of any road treatment.

Asphalt Concrete shall conform to Section 39, "Asphalt Concrete", of the Standard Specifications, and these Special Provisions.

Asphalt concrete shall be as follows:

USE	TYPE
0.167-foot Asphalt Concrete Wearing Course with fiber reinforcing	1/2-inch Maximum, Medium Grade Type A

The asphalt concrete mix shall conform to Section 39, "Asphalt Concrete", and 92, "Asphalt Binders", of the Standard Specifications. Asphalt concrete shall be grade PG 64-16.

Paving shall be accomplished using a shoulder paving machine, or paving machine capable of paving the widths required for this project.

39-2.01A(3)(a)(i) – FIBER REINFORCEMENT

Hot mix asphalt fiber shall be aramid *Ace XP Polymer fiber*, *FORTA-FI HMA fibers*, or an approved equivalent.

Aramid fibers must be treated to prevent them from becoming airborne during the mixing process, and the treatment must become soluble in the asphalt. Treated aramid fiber shall be continuously fed and mixed into HMA or WMA per dosage and mixing requirements of this specification

Fiber shall meet the following material properties.

<u>Aramid Properties</u>	<u>Measure</u>
Material	Para-Aramid Fiber
Form	Filament Yarn
Tensile Strength	> 400 (ksi)
Specific Gravity	0.91-1.45 (g/cm ³)
Decomposition Temperature	> 800 (°F)

<u>Short Cut Aramid Fiber Bundles</u>	<u>Measure</u>
Length	Min 0.75 +/-0.05 (inch)
Appearance/Handling	Free Flowing Coated Fiber Bundles (visual)

Provide the following from the product supplier at least two weeks prior to asphalt production.

1. Identify the mixing plant and type (Batch or Continuous Drum).
2. Material data sheet for the treated aramid fiber describing aramid fiber and treatment properties, including the type, weight, and flash point of treatment material.
3. A QA/QC mixing plan including procedures for continuously feeding the aramid fiber into the asphalt. The continuous feeding can be accomplished by using either manual or machine operated equipment for the entire fiber mixing process.

Dosage & Mixing Requirements.

The minimum aramid dosage rate is 2.1 ounces (+/- 5%) per ton of HMA. This does not include the treatment weight. For uniform disbursement, treated aramid shall be metered and continuously fed in a constant stream-like manner. It shall be mixed with the heated aggregates before injection of the liquid asphalt during the asphalt mixing process at the Batch or Continuous Drum Plant per below.

1. Batch Plant

Feed treated aramid manually, or with machine operated equipment, onto RAP or aggregate belts, or directly into the pug mill or weigh hopper. Standard project HMA batch mixing times apply. Metering shall be based on batch size (tons) and dosage rate (oz/ton). Feeding shall occur in a constant stream-like manner during the heated aggregate mixing batch time. If necessary, increase the mixing time with heated aggregates to ensure the aramid fibers are uniformly distributed.

2. Continuous Drum Plant

Feed treated aramid manually, or with machine operated equipment, onto the RAP belt or directly into the mixing drum through the RAP Collar. Standard project HMA asphalt production rates apply. Metering shall be calibrated based on the asphalt production rate (tons/hr), and the dosage rate (oz/ton). Feeding shall occur in a constant stream-like manner. If necessary, increase the mixing time with heated aggregates to ensure the aramid fibers are uniformly distributed.

The Contractor shall submit an asphalt concrete mix design with substantiating laboratory test results to the Engineer at least two weeks prior to paving operations. The testing laboratory selected by the Contractor shall be under the direction of a California registered Civil Engineer and subject to approval by the County. The Contractor's submittal shall as a minimum consist of Items 1 through 4 below. However, submittal of items 2 through 4 may be waived at the Engineer's option if the Contractor's mix design is satisfactory and has been approved by the County.

1. Proposed gradation of mix and Contractor's bin percentages used to obtain this gradation.

2. Completed worksheets for asphalt concrete mix design in accordance with procedures specified by California Test No. 367.
3. Results for the following tests of the mix incorporating the asphalt binder and aggregate proposed for use:
 - a. Stability of specimen (Ca. Test No. 366) at optimum bitumen content.
 - b. Swell test of specimen (Ca. Test No. 305) at optimum bitumen content.
 - c. Moisture vapor susceptibility of specimen (Ca. Test No. 307) at optimum bitumen content.
4. Results for the following tests of the aggregate proposed for use:
 - a. Sand equivalent (Ca. Test No. 217) of combined aggregate.
 - b. Percentage of crushed particles (Ca. Test No. 205).
 - c. Aggregate wear - 500 rev. (Ca. Test No. 211).
 - d. K_c and K_f factors (Ca. Test No. 303).

The Engineer will review the submittal, and, if acceptable, will give approval of the mix design within 5 working days. The Contractor shall not proceed with paving operations until the mix design is approved for this project. Caltrans preapproved mix designs are acceptable. The percentage of bitumen to be used in the asphalt concrete mix will be as designated by the Engineer.

The cost for asphalt concrete trench patch will be included in other items of work. Fiber reinforcement for HMA used for trench patching is NOT required. The cost for asphalt concrete used to fill recessed markers will be included in other items of work. Fiber reinforcement for HMA used for filling marker recesses is NOT required.

HMA tie ins on Dog Bar, Bobcat Court, and Cougar Court shall be done via a 30' taper grind. Driveway tapers may be done via an asphalt concrete taper

39-1.04 PAYMENT

The contract unit price paid for fiber reinforced HMA 64-16 shall include full compensation for furnishing all labor, materials, tools, equipment, and incidentals for doing all the work involved in the paving operations, metering/mixing of fibers, including the paving of driveway tie ins, grinding of tapers, and no additional compensation will be allowed.

39-2.01C(15)(b) Method Compaction

Add the following: County will supply a thin lift Nuclear gauge and tester to test in place density of HMA. Contractor will coordinate with the tester and make any needed changes to the rolling pattern to achieve the necessary density.

SECTION 78 INCIDENTAL CONSTRUCTION

78-21 RESETTING AND RELOCATING MAILBOXES

Resetting and relocating of mailboxes shall conform to Section 78-21, "Resetting and Relocating Mailboxes", of the Standard Specifications, and these Special Provisions.

Existing mailboxes shall be removed and reset in accordance with the locations shown on the plans or as directed by the Engineer.

During construction operations, the mailboxes shall be moved as necessary to clear the way for the Contractor's operations, but at all times shall be accessible for delivery. During construction, the mailboxes shall either be installed on posts set in the ground or they may be installed on temporary supports approved by the Engineer.

All mailboxes clustered onto a group mounting shall be considered a single mailbox for payment purposes. All new or relocated mailboxes shall meet current U.S. Postal Service standards for traffic safe installations.

When construction is complete the mailboxes shall be installed in final position set in minor concrete as directed by the Engineer.

Newspaper boxes attached to existing mailbox posts shall be removed and fastened to the new mailbox posts and no separate payment will be made therefor.

78-21.04 PAYMENT

Full compensation for disposing of existing posts and mounts, moving, and maintaining the boxes, regardless of the number of moves required, and for furnishing new posts, concrete and hardware shall be considered as included in other items of work and no additional compensation will be allowed therefor.

DIVISION IX TRAFFIC CONTROL DEVICES

SECTION 81 MISCELLANEOUS TRAFFIC CONTROL DEVICES

SECTION 81-3 PAVEMENT MARKERS

Pavement Markers shall conform to Sections 81-3, "Pavement Markers", and 82-9, "Existing Roadside Signs and Markers", of the Standard Specifications, and these Special Provisions.

The contract item price paid for remove and replace recessed pavement markers (new) shall include full compensation for removal of existing markers, fill of recesses with HMA and compaction, providing and installing new pavement markers, and grinding new recesses, and no additional compensation will be allowed.

81-3.03E REMOVE AND REPLACE RECESSED PAVEMENT MARKERS

Removal and replacement of recessed pavement markers shall be in conformance with the description of work. Pavement markers shall conform to Sections 81-3, "Pavement Markers", and 81-8.03B, "Remove Pavement Markers", of the Standard Specifications, Standard Plans A20D, and these Special Provisions.

The contract item price paid for Remove and Replace Recessed Pavement Markers shall include full compensation for providing and installing new pavement markers, removing old markers, filling existing marker recesses with **3/8" HMA** compacted to 95% RC, disposing of old markers, and regrinding new recesses, and no additional compensation will be allowed.

Section 81-8.04 Payment shall be amended to read:

"The contract item price paid for raised pavement markers shall include full compensation for providing and installing new pavement markers, removing old markers, filling existing recesses, 3/8" MHA used to fill existing recesses, compaction of HMA, and disposing of old markers, include full compensation for all material, tools, incidentals and no additional compensation will be allowed.

SECTION 82 SIGNS AND MARKERS

82-3.02A GENERAL

Replace item #1 in the 2nd paragraph in section 82-2.02A with:

1. Phrase *Property of the County of Nevada*

82-3.02D COUNTY FURNISHED SIGN

Contractor shall install two County furnished construction sign were directed by the engineer. The sign shall be mounted on two 4"x4" posts. Contractor shall furnish all hardware, posts, and

materials to install the sign. Upon completion of the project contractor shall remove and return the County sign to the Engineer.

82-3.02E PAYMENT

The contract unit price paid for "Install County Furnished Sign" shall include full compensation for providing and installing all hardware, posts, and materials, and upon project completion, removal and return transportation of the County's sign, and no additional compensation will be allowed.

SECTION 84 MARKINGS

84-1.01 GENERAL

All paint and thermoplastic striping shall be 4-inches wide unless noted otherwise.

84-1.01A STRIPE LOCATIONS

All centerlines and turn pockets shall be marked or "Cat-tracked" by the contractor for approval by the Engineer prior to application of paint. Contractor shall document the location of all striping and markings prior to obliteration.

84-2 TRAFFIC STRIPES AND PAVEMENT MARKINGS

84-2.01 GENERAL

The application of traffic stripes (traffic lines) and pavement markings shall conform Sections 84-2.01, "General", and 84-2.03C(3), "Painted Traffic Stripes and Pavement Markings," of the Standard Specifications, and these Special Provisions.

Contractor's attention is directed to Section 84-2.02, "Materials". The contractor will be required to satisfy all local, State and Federal pollution control regulations in effect at time of application.

Paint

The contract prices paid per linear foot for Detail 27B 4" paint, and Detail 21 4" paint, of the number of coats designated in the Engineer's Estimate shall include full compensation for furnishing all labor, materials, tools, equipment and incidentals, and for doing all work involved in painting traffic stripes (regardless of the number, widths and patterns of individual stripes involved in each traffic stripe) and pavement markings, including any necessary cat tracks, dribble lines, layout work, temporary delineation, traffic control and any sweeping required, complete in place, in conformance with the Standard Specifications and these Special Provisions, and as directed by the Engineer.

A double yellow stripe consisting of 2 4-inch lines will be measured and paid for as one traffic stripe.

Two coats of paint are required on all new pavement and micro-surfacing.

84-2.04 PAYMENT

Section 84-2.04, "Payment", is amended to read:

<u>Double Yellow with Black (4-inch) - Caltrans Detail 21 or 22</u>	
<p>DETAIL 21</p> <p>DETAIL 22</p>	<p>A double yellow stripe (with black) consisting of two 4-inch lines as shown in Caltrans Detail 21 or 22 shall be measured and paid for per linear foot as one traffic stripe.</p>
<u>Median Islands – Caltrans Detail 28 or 29</u>	
<p>DETAIL 28</p> <p>DETAIL 29</p>	<p>Median islands as shown in Caltrans Detail 28 or 29 shall be measured and paid per linear foot of individual double yellow stripe as described above. Quantities for Median Islands are included in these specifications as Double Yellow with Black, not as their own separate entry.</p>
<u>Edgeline or Dashed Edgeline (4-inch) – Caltrans Detail 27B or 27C</u>	
<p style="text-align: center;"><u>RIGHT EDGELINES</u></p> <p>DETAIL 27A DETAIL 27A DELETED</p> <p>DETAIL 27B</p> <p style="text-align: center;"><u>RIGHT EDGELINE EXTENSION THROUGH INTERSECTIONS</u></p> <p>DETAIL 27C</p>	<p>A single 4-inch solid or dashed white edgeline as shown in Caltrans Detail 27B or 27C shall be measured and paid as one continuous stripe with the same price per linear foot for both solid and dashed lines.</p>

Pass/No-Pass with Black (4-inch) – Caltrans Detail 18 or 19

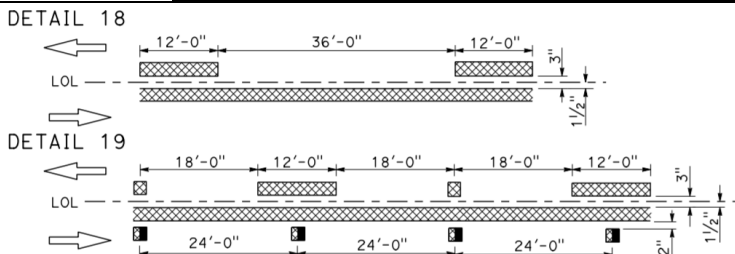

A solid/dashed stripe consisting of two 4-inch yellow lines (with black) as shown in Caltrans Detail 18 or 19 shall be measured and paid for per linear foot as one traffic stripe.

Two-Way Left Turn Lanes – Caltrans Detail 31 or 32

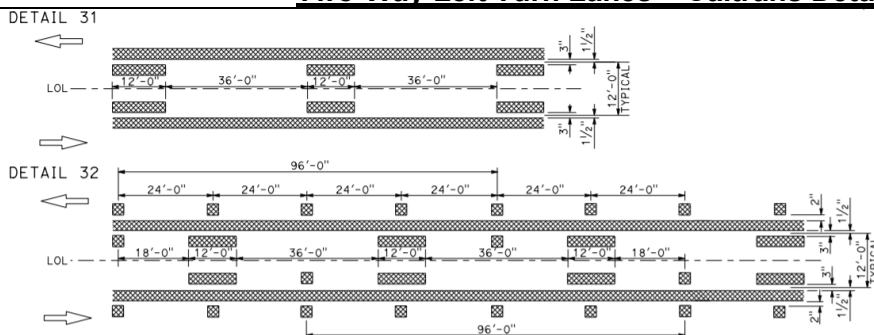

Two-way left turn lanes as shown in Caltrans Detail 31 or 32 shall be measured and paid per linear foot of individual pass/no-pass stripe as described above. Quantities for two-way left turn lanes are included in these specifications as Pass/No-pass with Black, not as their own separate entry.

Dashed Centerline with Black (4-inch) – Caltrans Detail 1 or 5

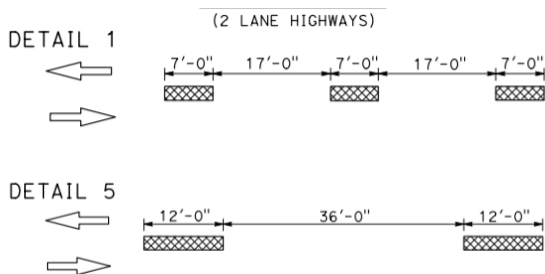

A single 4-inch dashed yellow centerline (with black) as shown in Caltrans Detail 1 or 5 shall be measured and paid per linear foot as one continuous stripe.

Channelizing (8-inch) – Caltrans Detail 38, 38A or 38B

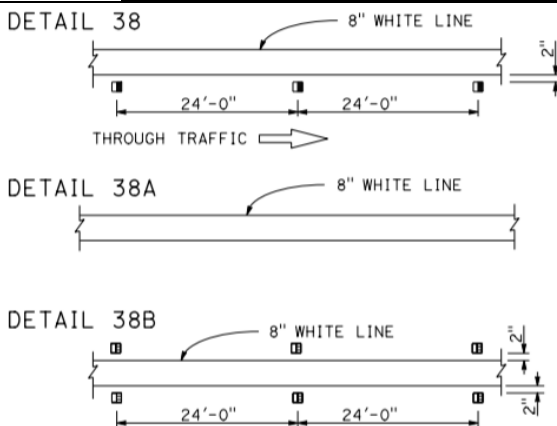

A single 8-inch solid line as shown in Caltrans Detail 38, 38A or 38B shall be measured and paid per linear foot as one continuous stripe.

The contract prices paid per linear foot for traffic stripe, shall include full compensation for furnishing all labor, materials, tools, equipment and incidentals, or any other items required and for doing all work involved in painting traffic stripes, thermoplastic traffic stripes (regardless of the number, widths and patterns of individual stripes involved in each traffic stripe), including any necessary cat tracks, dribble lines, protecting existing markers, layout work, sweeping required, complete in place,

as specified in these Specifications and the Special Provisions, and as directed by the Engineer. **A double yellow stripe (Detail 21) consisting of 2-4 inch lines will be measured and paid for as one traffic stripe.**

84-9 EXISTING MARKINGS

84-9.01 GENERAL

Section 84-9 includes specifications for removing existing markings.

Work performed on existing markings must comply with section 15.

84-9.03B REMOVE TRAFFIC STRIPES AND PAVEMENT MARKINGS

Section 84-9.03B, "Remove Traffic Stripes and Pavement Markings", is amended to read:

Completely remove traffic stripes and pavement markings, including any paint in the gaps, by methods that do not remove pavement to a depth of more than 1/8 inch.

Submit your proposed method for removing traffic stripes and pavement markings at least 7 days before starting removal work. Allow 2 business days for the review.

Sweep up or vacuum any residue before it can (1) be blown by traffic or wind, (2) migrate across lanes or shoulders, or (3) enter a drainage facility.

84-9.04 PAYMENT

Section 84-9.04, "Payment", is amended to read:

The contract prices paid per linear foot for Remove Traffic Stripes and Pavement Markings shall include full compensation for furnishing all labor, materials, tools, equipment and incidentals, and for doing all work involved in removal of traffic stripes and pavement markings (regardless of the number, widths and patterns of individual stripes involved in each traffic stripe). Disposal of waste materials collected in the process of removing traffic stripes and pavement markings is the responsibility of the contractor and may not be disposed on within Nevada County right-of-way. No additional compensation will be allowed.

PROJECT MAP

Project Vicinity Map 2023 Road Rehabilitation Project

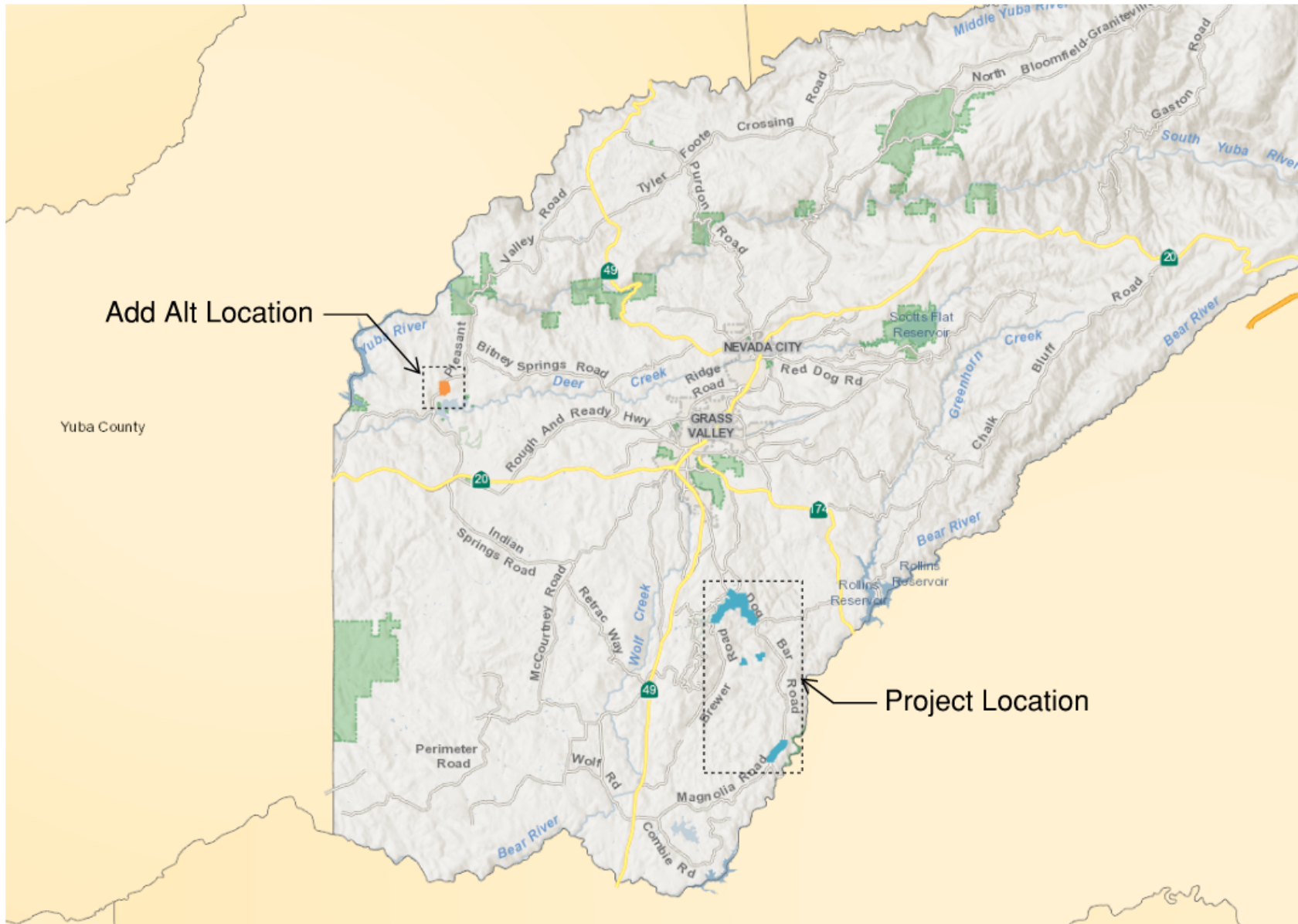

Project Location Map

2023 Road Rehabilitation Project

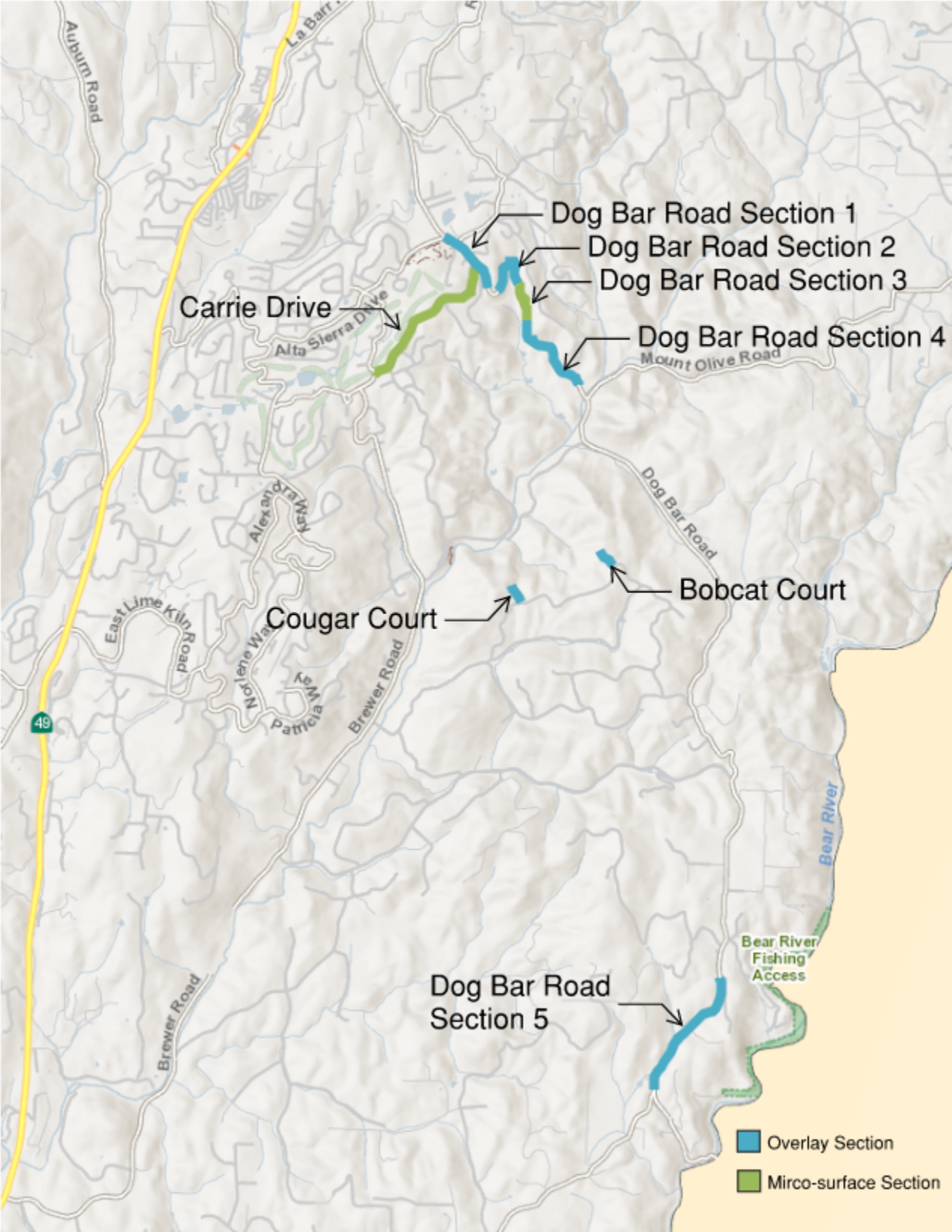

Add Alt Location Map 2023 Road Rehabilitation Project



Shoulder Widening/AC Dike Location Map 2023 Road Rehabilitation Project

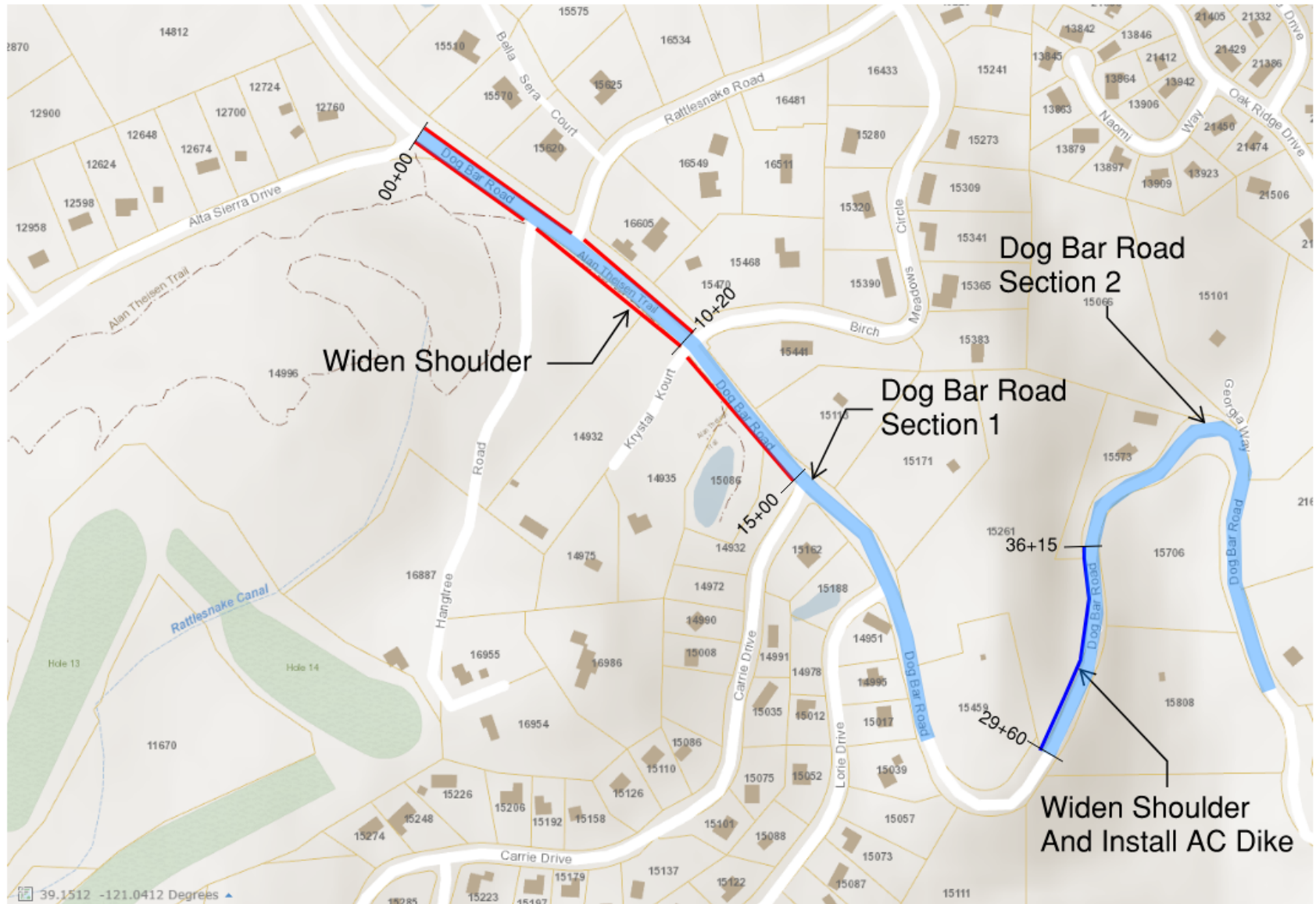

Shoulder Widening/AC Dike Location Map 2023 Road Rehabilitation Project

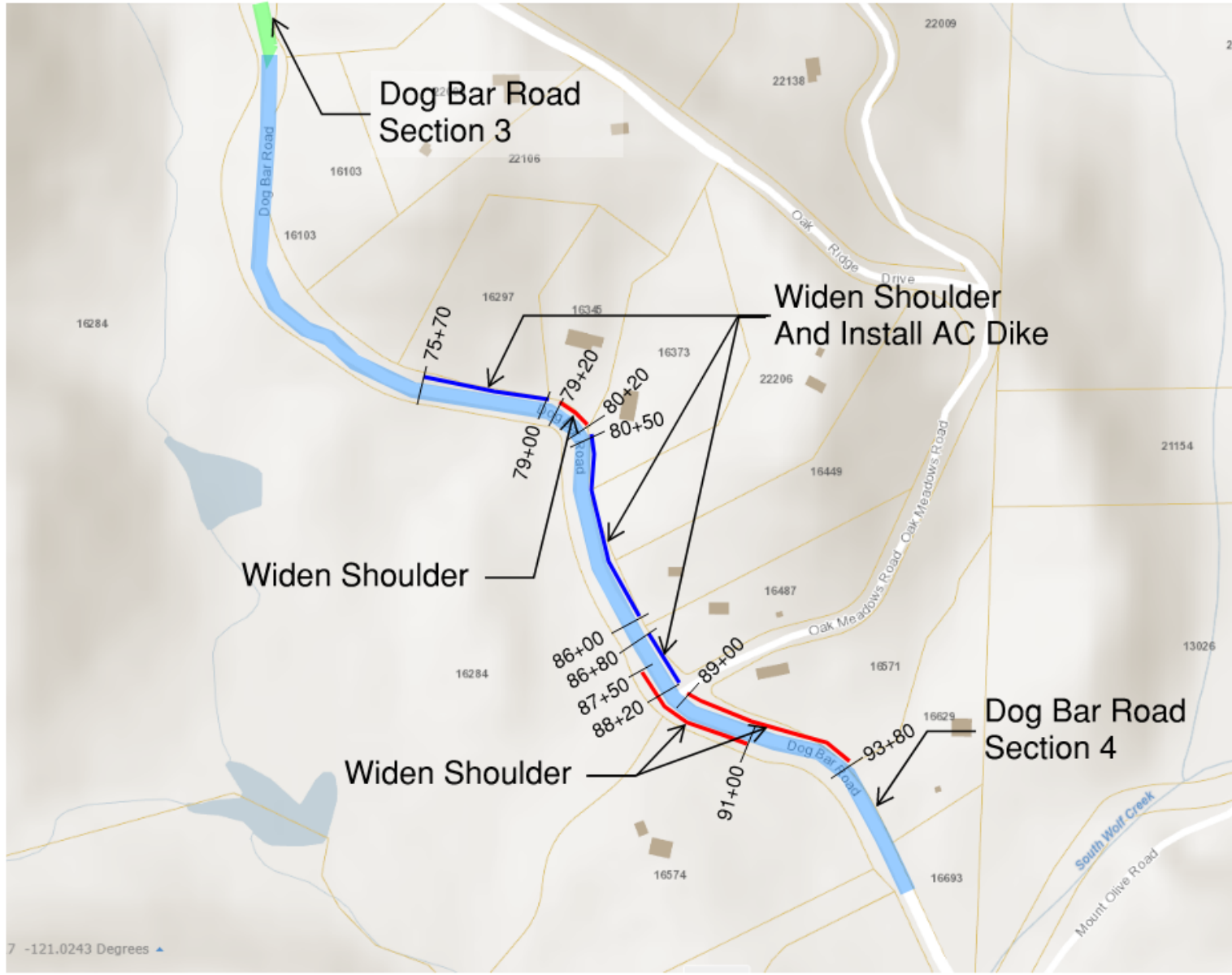

APPROXIMATE QUANTITIES BY ROAD

2023 Road Rehabilitation Project

Approximate Quantities

Road Name	From	To	Length FT	Average Width FT	Area SF	Digout & Repair SF	Shoulder Widening LF	Shoulder Backing CY	Crack Treatment Lane Foot	Micro- Surfacing Type II SF	Fiber Reinforced HMA 64-16 Tons	Remove & Replace Recessed Pavement Marker EA	Detail 38A 8" Paint (White) LF	Detail 21 4" Paint (Yellow w/ Black) LF	Detail 27B 4" Paint (White) LF	AC Dike Type A LF	Remove Traffic Stripes and Pavement Markings LF
Dog Bar Road Section 1	Alta Sierra Drive (00+00)	22+00	2,200	24.8	54,560	-	2,520	49	5,920	-	708	246	-	2,960	5,920	-	8,880
Dog Bar Road Section 2	29+60	49+50	1,990	24.0	47,760	-	655	44	3,980	-	640	166	-	1,990	3,980	655	5,970
Dog Bar Road Section 3	49+50	64+00	1,450	28.7	41,615	-	-	-	2,900	42,361	-	121	-	1,450	2,900	-	4,350
Dog Bar Road Section 4	64+00	97+00	3,300	22.6	74,547	-	1,950	73	6,600	-	1,062	275	-	3,300	6,600	1,020	9,900
Dog Bar Road Section 5	Morning Sun Lane	Magnolia Road	4,812	25.3	121,498	9,378	-	119	9,624	-	1,468	401	-	4,812	9,624	-	14,435
Carrie Drive	Dog Bar Road	Gary Way	5,712	25.4	144,799	11,997	-	-	11,424	144,799	-	476	48	5,712	11,424	-	17,136
Cougar Court	Buck Ridge Road	End	715	29.2	20,878	-	-	-	-	-	253	-	-	-	-	-	-
Bobcat Court	Buck Ridge Road	End	760	26.9	20,444	-	-	-	-	-	248	-	-	-	-	-	-
					Total		5,125	285	40,448	187,160	4,380	1,685	48	20,224	40,448	1,675	60,671
Add Alt																	
Gold Country Drive	Pleasant Valley Road	End	3,672	26.2	96,217	-	-	-	-	96,217	-	-	-	3,672	-	-	-

CONSTRUCTION DETAILS

2023 ROAD REHABILITATION PROJECT

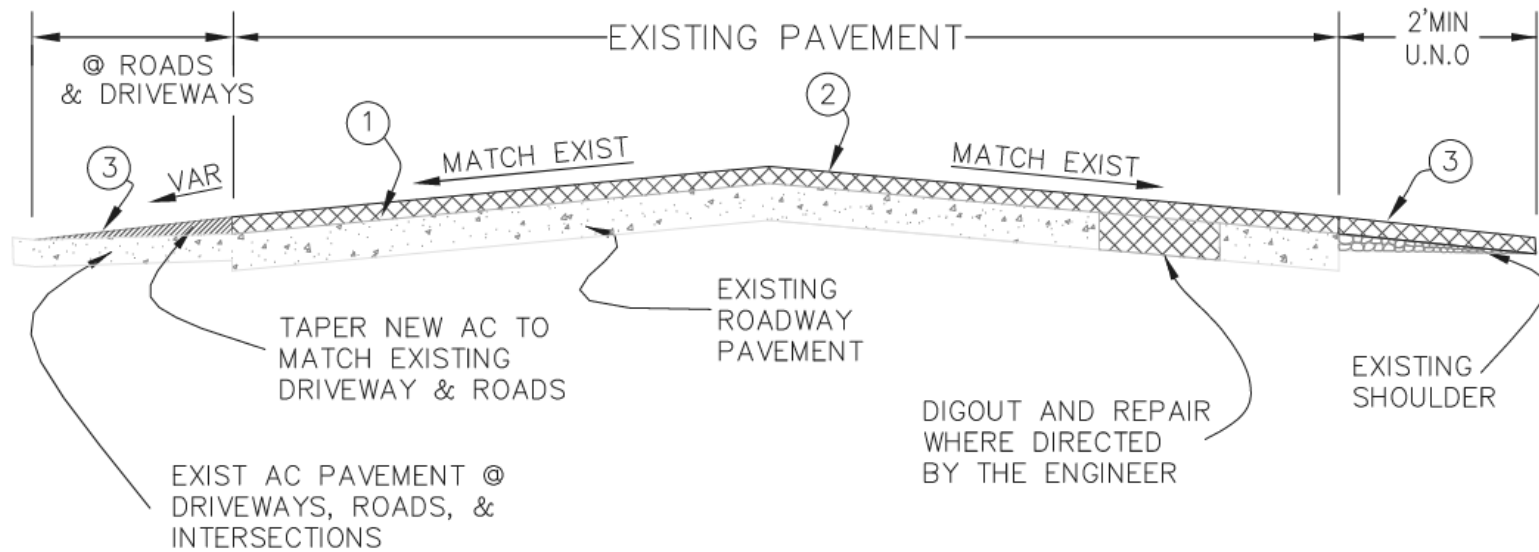

- ① APPLY TACK-COAT TREATMENT.
- ② APPLY 0.167' WEARING COARSE ($\frac{1}{2}$ " MIX W/ REINFORCING FIBERS)
- ③ WHERE DIRECTED TO WIDEN SHOULDER:
MATCH EXISTING PAVEMENT W/ CLASS II A B COMPACTED TO 95% RC
APPLY 0.167' WEARING COARSE ($\frac{1}{2}$ " MIX W/ REINFORCING FIBERS)

2023 ROAD REHABILITATION PROJECT

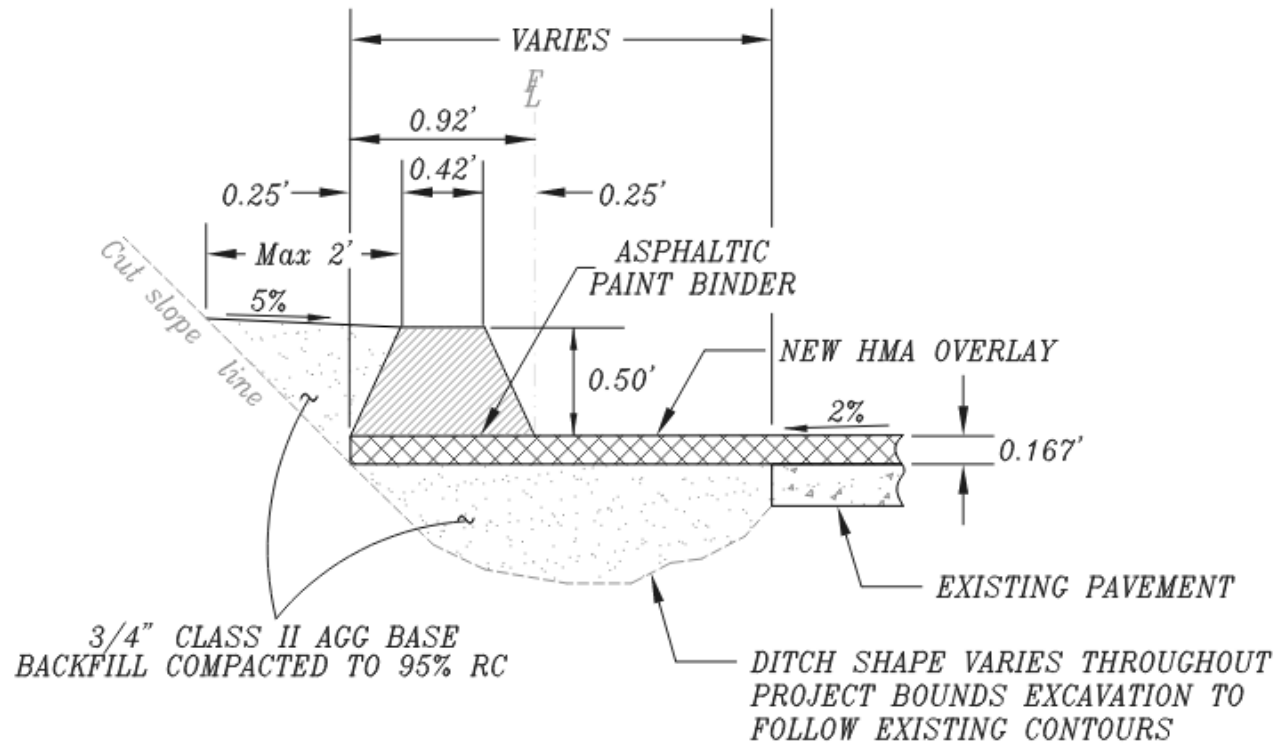

TYPE A (HIGH DIKE)
IN CUT

NOTICE TO BIDDERS:

THE FOLLOWING CONTRACT SECTION IS INCLUDED

AS A SAMPLE

FOR INFORMATION ONLY

AND IS NOT TO BE

COMPLETED WITH BID

COUNTY OF NEVADA
STATE OF CALIFORNIA

CONTRACT

FOR

2023 Road Rehabilitation Project

COUNTY CONTRACT NO. 450011

April 13, 2023

(Standard Public Works Contract)

COUNTY OF NEVADA
DEPARTMENT OF PUBLIC WORKS

PERFORMANCE BOND

(To Accompany Contract)

Bond No. _____

WHEREAS, the County of Nevada, acting by and through the Department of Public Works, has awarded to Contractor _____, hereafter designated as the "Contractor", a contract for the work described as follows:

AND WHEREAS, the Contractor is required to furnish a bond in connection with said contract, guaranteeing the faithful performance thereof:

NOW, THEREFORE, we the undersigned Contractor and Surety are held firmly bound to the County of Nevada in the sum of _____

_____ dollars (\$ _____), to be paid to said County or its certain attorney, its successors and assigns: for which payment, well and truly to be made, we bind ourselves, our heirs, executors and administrators, successors or assigns, jointly and severally, firmly by these presents.

THE CONDITION OF THIS OBLIGATION IS SUCH,

That if the above bound Contractor, its heirs, executors, administrators, successors or assigns, shall in all things stand to and abide by, and well and truly keep and perform the covenants, conditions and agreements in the foregoing contract and any alteration thereof made as therein provided, on his or their part to be kept and performed at the time and in the manner therein specified, and in all respects according to their intent and meaning, and shall indemnify and save harmless the County of Nevada, its officers and agents, as therein stipulated, then this obligation shall become and be null and void; otherwise it shall be and remain in full force and virtue.

IN WITNESS WHEREOF, We have hereunto set our hands and seals on this _____ day of _____, 20__.

Correspondence or claims relating to this bond should be sent to the surety at the following address: _____ Contractor

Surety (SEAL)

By: Attorney-in-Fact

NOTE: Signatures of those executing for the surety must be properly acknowledged.

CERTIFICATE OF ACKNOWLEDGEMENT

State of California, County of Nevada SS

On this _____ day of _____ in the year 20 ____ before me _____,
personally appeared _____, personally

Attorney-in-fact

known to me (or proved to me on the basis of satisfactory evidence) to be the person whose name
is subscribed to this instrument as the attorney-in-fact of _____
and acknowledged to me that he/she subscribed the name of the said company thereto as surety,
and his/her own name as attorney-in-fact.

(SEAL)

Notary Public

COUNTY OF NEVADA
DEPARTMENT OF PUBLIC WORKS

PAYMENT BOND
(Section 3247, Civil Code)

WHEREAS, The County of Nevada, acting by and through the Department of Public Works, hereafter referred to as "Obligee", has awarded to Contractor _____, hereafter designated as the "Contractor", a contract for the work described as follows:

AND WHEREAS, said Contractor is required to furnish a bond in connection with said contract, to secure the payment of claims of laborers, mechanics, materialmen, and other persons as provided by law.

NOW, THEREFORE, we the undersigned Contractor and Surety are bound unto the Obligee in the sum of _____ dollars (\$ _____), for which payment, we bind ourselves, jointly and severally.

THE CONDITION OF THIS OBLIGATION IS SUCH,

That if said Contractor or its subcontractors shall fail to pay any of the persons named in Civil Code Section 3181, or amounts due under the Unemployment Insurance Code with respect to work or labor performed by such claimant, or any amounts required to be deducted, withheld, and paid over to the Franchise Tax Board for the wages of employees of the Contractor and his subcontractors pursuant to Section 18806 of the Revenue and Taxation Code, with respect to such work and labor, that the surety herein will pay for the same in an amount not exceeding the sum specified in this bond, otherwise the above obligation shall be void. In case suit is brought upon this bond, the surety will pay a reasonable attorney's fee to be fixed by the court.

This bond shall inure to the benefit of any of the persons named in Civil Code Section 3181 as to give a right of action to such persons or their assigns in any suit brought upon this bond.

Dated: _____, 20 ____

Correspondence or claims relating to this bond
should be sent to the surety at the following address: Contractor _____

Surety (SEAL)

By: Attorney-in-Fact

NOTE: Signatures of those executing for the surety must be properly acknowledged.

CERTIFICATE OF ACKNOWLEDGEMENT

State of California, County of Nevada SS

On this _____ day of _____ in the year 20 ____ before me _____,
personally appeared _____, personally

Attorney-in-fact

known to me (or proved to me on the basis of satisfactory evidence) to be the person whose name
is subscribed to this instrument as the attorney-in-fact of _____
and acknowledged to me that he/she subscribed the name of the said company thereto as surety,
and his/her own name as attorney-in-fact.

(SEAL)

Notary Public

**COUNTY OF NEVADA
STATE OF CALIFORNIA**

CONTRACT

THIS CONTRACT, made this __ day of _____ by and between the COUNTY OF NEVADA, hereinafter referred to as County and _____, hereinafter referred to as Contractor.

WITNESSETH: That the County and Contractor, for the consideration hereinafter mentioned, agree as follows:

ARTICLE I: DEFINITIONS

Wherever used in these general conditions or in the other contract documents the following terms have the meanings indicated which are applicable to both the singular and plural thereof:

Act of God

"Act of God" means an earthquake or flood, or other cataclysmic phenomenon of nature. A rain, windstorm, high water, or other natural phenomenon of unusual intensity for the specific locality of the work, which might reasonably have been anticipated from historical records of the general locality of the work, shall not be construed as an Act of God.

Addenda

Written or graphic instruments issued prior to the opening of bids which clarify, correct, or change the bidding documents.

Application for Payment

The form accepted by County which is to be used by Contractor in requesting progress or final payments and which is to include such supporting documentation as is required by the contract documents.

Calendar Days

Consecutive days of the month including Saturdays, Sundays, and holidays. A calendar day shall be the 24 hours running from midnight to the next midnight.

Change Order

A document, which is signed by Contractor and County and authorizes an addition, deletion or revision in the work, or an adjustment in the contract price or the contract time, issued on or after the effective date of the contract.

Contract Documents

The written agreement covering the performance of the work and the furnishing of labor, materials, and equipment in construction of the work. The agreement shall be construed to include the

1. Invitation to Bid
2. Instructions to Bidders
3. Contractor's Bid (including documentation accompanying the Bid and any post-bid documentation submitted prior to the Notice of Award)
4. Contract
5. Addenda which pertain to the Contract
6. The Bonds
7. Any supplementary conditions or any and all written agreements amending or extending the work, time or price contemplated
8. The Plans and Specifications and Drawings as identified in the Contract
9. Certificates of Insurance
10. Other: _____

Contract Price

Either the total lump sum bid of the Contractor, or the total of the unit price bids of the Contractor extended based upon the estimated quantities set forth in the bid, or combinations thereof, plus or minus any adjustments made in accordance with the contract.

Contractor

The person or persons, co-partnership, joint venturers, or corporation who have entered into a contract with County as party or parties of the second part and/or their legal representatives.

Contractor's Plant and Equipment

Everything, except labor, brought onto the site by the Contractor in order to carry out the work, but not to be incorporated in the work.

County

The County of Nevada and any person or persons to whom the power belonging to County shall be duly designated including but not limited to an engineer or architect. Only those persons designated in writing by the County Administrator or Director of the department overseeing the project shall have authority to act on behalf of County.

Day

A calendar day of 24 hours, except when preceded by "working", as defined below.

Defective

An adjective which when modifying the word "work" refers to work that is unsatisfactory, faulty, or deficient, or does not conform to the contract documents, or does not meet the requirements of any inspection, reference standard, test or approval referred to in the contract documents, or has been damaged (unless responsibility for the protection thereof has been assumed by County).

Directed

"Directed", "designated", "permitted", "required", "accepted", and words of like import, wherever and in whatever manner used means as directed, designated, permitted, required, and accepted by County.

Director

"Director" shall mean the Director of the department overseeing the project.

Drawings

The drawings which show the character and scope of the work to be performed and which have been prepared or approved by County and are referred to in the contract documents.

Effective Date of the Contract

The date indicated in the Contract on which it becomes effective, but if no such date is indicated it means the date on which the Contract is signed and delivered by the last of the two parties to sign and deliver.

Engineer

The person specifically designated in writing by County to function as staff adviser and/or consultant to County on engineering matters relating to this contract. Only those persons designated by County, in writing, shall have authority to act for County in the administration of this contract. Said written designation shall be signed by the County Administrator or Director of the department overseeing the project.

Equal

A device, material, equipment, technique, or method that conforms to the intent of that specified or indicated on the Drawing.

Field Order

A written order issued by County which orders minor changes in the work, but which does not involve a change in the contract price or the contract time.

Final Acceptance, Date of

The date when all final punch list items are corrected, the final inspection has been completed and when the governing body and/or funding agency formally accepts the project as complete. This date will be used to establish the start date of the one-year warranty period for the contract.

Laboratory

The designated testing laboratory authorized by County to test materials and work involved in the contract.

Lien

Any claim by a person entitled to file a stop notice pursuant to the provisions of California Civil Code Sections 3179, et seq.

Notice of Award

The written notice by County to the apparent successful bidder stating that upon compliance by the apparent successful bidder with the condition's precedent enumerated therein, within the time specified, County will sign and deliver the Contract.

Notice to Proceed

A written notice given by County to Contractor fixing the date on which the contract time will commence to run and on which Contractor shall start to perform Contractor's obligations under the Contract Documents.

Partial Completion

Placing a portion of the work in service for the purpose for which it is intended (or a related purpose) before reaching completion of all the work.

Person

Includes firms, companies, and corporations.

Project

The total construction which is required by the Contract Documents which may be all of the work, or a part as indicated in the Contract Documents.

Schedule of Values

A list of divisions of the total scope of work under the contract made by the Contractor and approved by the County for purposes of progress payments.

Shall

"Shall" or "will", whenever used, is mandatory.

Shop Drawings

All drawings, diagrams, illustrations, schedules, and other data which are specifically prepared by or for Contractor to illustrate some portion of the work and all product data illustrations, brochures, standard schedules, performance charts, instructions, diagrams, samples, and other information prepared by a supplier and submitted by Contractor to illustrate material or equipment for some portion of the work.

Special Provisions

Those portions of the Contract Documents consisting of written technical descriptions of materials, equipment, construction systems, standards and workmanship as applied to the work and certain administrative details applicable thereto.

Standard Specifications

Specifications which are authored and authorized by a particular industry or agency which may be incorporated by reference. Where so incorporated, they are incorporated for use of technical data and specifications only. If there is a conflict between the standard specifications and express terms of this contract, the provisions set forth in the contract shall prevail.

Subcontractor

An individual, firm or corporation having a direct contract with Contractor or with any other subcontractor for the performance of a part of the work at the site.

Substitute

A device, material, equipment, technique, or method of construction that differs from that intended or indicated on the Drawings.

Sufficient:

"Sufficient", "necessary", "proper", "acceptable", "satisfactory", "desirable", and words of like import, wherever and in whatever manner used, with or without reference to the County, means sufficient, necessary, proper, acceptable, satisfactory, and desirable in the judgment of the County.

Supplementary Conditions

An addition to the Contract Documents which supplements the main Contract.

Underground Facilities

All pipelines, conduits, ducts, cables, wires, manholes, vaults, tanks, tunnels or other such facilities or attachments, and any encasements containing such facilities which have been installed underground to furnish any of the following services or materials: electricity, gases, steam, liquid petroleum products, telephone or other communications, cable television, sewage and drainage removal, traffic or other control systems or water.

Unit Price Work

Work to be paid for on the basis of unit prices.

Work

The entire completed construction or the various separately identifiable parts thereof required to be furnished under the Contract Documents. Work is the result of performing services, furnishing labor, and furnishing and incorporating materials and equipment into the construction, all as required by the Contract Documents.

Working Day

A working day is any day except Saturdays, Sundays, or legal holidays and days on which the Contractor is specifically required by Special Provisions, by any labor contract, or by law, to suspend construction operations. Also excepted is any day on which the Contractor is prevented by inclement weather conditions resulting therefrom, or other phenomena of nature from proceeding with at least seventy-five percent (75%) of the normal labor and equipment force for at least five (5) hours toward completion of the current controlling item on the accepted project schedule. Should the conditions prevent the work from beginning at the usual starting time, or prevent the Contractor from proceeding with seventy-five percent (75%) of the normal labor and equipment force for a period of at least five (5) hours, and the crew is dismissed as a result thereof, Contractor will not be charged for a working day whether or not conditions change so that the major portion of the day could be considered to be suitable for work on the controlling item.

ARTICLE II: SCOPE OF WORK

Contractor, at Contractor's own proper costs and expense, shall do all the work and furnish all the materials necessary to construct and/or reconstruct and complete in good workmanlike and substantial manner and to the satisfaction of the County, the following: **2023 Road Rehabilitation Project**, which shall be constructed in accordance with this Contract, the Invitation to Bid, the Instructions to Bidders, the Plans and Specifications and Drawings, and all other contract documents attached hereto and which are incorporated herein by reference and made a part of this Contract as if set forth in full.

ARTICLE III: CONTRACT TIME

Contractor will start work to be performed under this Contract within **7 days** after the Contractor is instructed in writing by County to proceed with the work. Said work shall be diligently prosecuted to

completion. **2023 Road Rehabilitation Project work shall be completed and ready for acceptance within 40 working days from the construction start date.** When any period of time is referred to in the contract documents by days, it will be computed to exclude the first and include the last day of such period. If the last day of any such period falls on a Saturday or Sunday or on a day made a legal holiday by the law of the applicable jurisdiction, such day will be omitted from the computation.

ARTICLE IV: CHANGE OF CONTRACT TIME

Change by Change Order

The contract time may only be changed by change order. A request for an extension or shortening of the contract time shall be based on written notice delivered by the party making the request to County promptly after the occurrence of the event giving rise to the request and stating the general nature of the request. Notice of the extent of the request with supporting data shall be delivered to County and shall be accompanied by the written statement that the adjustment requested is the entire adjustment to which the requesting party has reason to believe it is entitled as a result of the occurrence of said event. No request for an adjustment in the contract time will be valid if not submitted in accordance with the requirements of this paragraph.

Contract Time May Be Extended

The contract time will be extended in an amount equal to time lost due to delays beyond the control of Contractor if the request is made therefor as provided in this Article. Such delays shall include, but not be limited to, acts of neglect by County or others performing additional work, or to fires, floods, labor disputes, epidemics, abnormal weather conditions or acts of God.

Delay and Price Change

All time limits stated in the contract documents are of the essence. There shall be no adjustment of contract price due to delays which are not caused by the County, including but not limited to delays for fires, floods, labor disputes, epidemics, abnormal weather conditions or acts of God and the acts of any other person or entity. The provisions of this Article shall not exclude recovery for damages for delay which is caused by the County.

Delays in Completion of the Work

1. Notice of Delays

Whenever the Contractor foresees any delay in the prosecution of the work, and in any event immediately upon the occurrence of any delay which the Contractor regards as unavoidable, Contractor shall notify County in writing of the probability of the occurrence of such delay and its cause in order that County may take immediate steps to prevent, if possible, the occurrence or continuance of the delay or, if this cannot be done, may determine whether the delay is to be considered avoidable or unavoidable, how long it continues, and to what extent the prosecution and completion of the work are to be delayed thereby. It will be assumed that any and all delays which have occurred in the prosecution and completion of the work have been avoidable delays, except such delays as shall have been called to the attention of County at the time of their occurrence and found by County to have been unavoidable. The Contractor shall make no requests for extensions of time as to delay not called to the attention of County at the time of its occurrence.

2. Avoidable Delays

Avoidable delays in the prosecution or completion of the work shall include all delays which in the opinion of County would have been avoided by the exercise of care, prudence, foresight, and diligence on the part of the Contractor or Contractor's subcontractors.

3. Unavoidable Delays

Unavoidable delays in the prosecution or completion of the work shall include all delays which, in the opinion of County, result from causes beyond the control of the Contractor and which could not have been avoided by the exercise of care, prudence, foresight and diligence on the part of the Contractor or the subcontractors and/or any suppliers. Delay in completion due to

contract modifications ordered by County and unforeseeable delays in the completion of work or interference by other contractors employed by County will be considered unavoidable delays insofar as they interfere with the Contractor's completion of the work.

Extension of Time

1. Avoidable Delays

In case the work is not completed in the time specified, including such extensions of time as may have been granted for unavoidable delays, the Contractor will be assessed damages for delay in accordance with the liquidated damages provision. The County, however, shall have the right to grant an extension of time for avoidable delay if it is deemed in County's best interest to do so. During such extension of time, the Contractor will be charged for engineering and inspection services and other costs but will not be assessed damages for the delay.

2. Unavoidable Delays

For delays which County considers to be unavoidable, the Contractor shall, pursuant to Contractor's application, be allowed an extension of time beyond the time herein set forth, proportional to such delay or delays, in which to complete the contract. During such extension of time, neither extra compensation for engineering and inspection provided nor damages for delay will be charged to the Contractor.

Liquidated Damages

County and Contractor recognize that time is of the essence and that County will suffer financial loss if the work is not completed within the time specified above, plus any extensions thereof allowed in accordance with this contract. They also recognize the delays, expense and difficulties involved in proving the actual loss suffered by County if the work is not completed on time. Accordingly, instead of requiring any such proof, and due to impracticality and difficulty of ascertaining exact damages caused by delay, County and Contractor agree that as liquidated damages for delay (but not as a penalty) the Contractor shall pay the County of Nevada the sum of **\$4,200.00** per day, for each and every calendar day's delay in finishing the work in excess of the number of working days prescribed above. Such damages shall only be payable by Contractor to County if the delay is a result of the failure of Contractor to timely perform on its part and not occasioned by the County or any State or Federal agency. In case of joint responsibility for delay in the final completion of the work, where two or more separate contracts are in force at the same time and cover work at the same site, liquidated damages assessed against any one Contractor will be based upon the individual responsibility of that Contractor for the delay as determined by, and in the judgment of, County. County shall have the right to deduct the liquidated damages from any money in its hands, otherwise due, or to become due, to Contractor, or to sue for and recover compensation for damages for nonperformance of this contract within the time stipulated. It is acknowledged that the subject contract is a public project which is subject to the provisions of the Public Contracts Code. Accordingly, County has determined, and the Contractor acknowledges that the liquidated damages as established herein are governed by the provisions of Government Code Section 53069.85 and are predicated upon the reasonable damages accruing to County stemming from any delay in the completion of this project.

ARTICLE V: CONTRACT PRICE

County shall pay Contractor for performance of the work in accordance with the Contract Documents in current funds as follows: _____ Dollars (\$ _____)

ARTICLE VI: CHANGE OF CONTRACT PRICE

Contract Price

The contract price constitutes the total compensation (subject to authorized adjustments) payable to Contractor for performing the work. All duties, responsibilities and obligations assigned to or undertaken by Contractor shall be at Contractor's expense without change in the contract price.

Change by Change Order

The contract price may only be changed by a written change order. Any request for an increase or decrease in the contract price shall be based on written notice delivered by the party making the request to the other party prior to the commencement of any extra work. Said request shall state the exact nature of the request.

Data regarding any change shall be delivered by Contractor prior to commencing extra work and shall be accompanied by Contractor's written statement that the amount requested covers all amounts (direct, indirect, and consequential) to which the Contractor is entitled as a result of the extra work to be done. If said request is granted, County will issue a written change order therefor. No request for an adjustment in the contract price will be valid if not submitted in advance and in accordance with this paragraph.

Determination of Change in Contract Price

The value of any work covered by a change order or of any request for an increase or decrease in the contract price shall be determined in one of the following ways:

1. Where the work involved is covered by unit prices contained in the contract documents, by application of unit prices to the quantities of the items involved (subject to the provisions regarding unit price work set forth below).
2. By mutual agreement, and if there is no mutual agreement, No. 3 directly below shall apply.
3. On the basis of the cost of the work determined as provided below plus a contractor's fee for overhead and profit as provided below.

Cost of the Work

The term "cost of the work" means the sum of all costs necessarily incurred and paid by Contractor in the proper performance of the extra work required or permitted under a change order. Except as otherwise may be agreed to in writing by County, such costs shall be in amounts no higher than those prevailing in the locality of the project and shall include only the following items:

1. Payroll costs for employees in the direct employ of Contractor in the performance of the work under schedules of job classifications agreed upon by County and Contractor. Payroll costs for employees not employed full time on the work shall be apportioned on the basis of their time spent on the work. Payroll costs shall include salaries and wages plus the cost of fringe benefits which shall include social security contributions, unemployment, excise and payroll taxes, workers' compensation, health and retirement benefits, sick leave, vacation, and holiday pay applicable thereto. Such employees shall include superintendents and foremen at the site. The expenses of performing work after regular working hours, on Saturday, Sunday, or legal holidays, shall be included in the above to the extent authorized by County in writing.
2. Cost of all materials and equipment furnished and incorporated in the work, including costs of transportation and storage thereof, and suppliers' field services required in connection therewith. All cash discounts shall accrue to Contractor unless County deposits funds with Contractor with which to make payments, in which case the cash discounts shall accrue to County. All trade discounts, rebates and refunds and all returns from sale of surplus materials and equipment shall accrue to County, and Contractor shall make provisions so that they may be obtained.
3. Payments made by Contractor to the subcontractors for work performed by subcontractors. If required by County, Contractor shall obtain competitive bids from subcontractors acceptable to Contractor and shall deliver such bids to County who will then determine which bids will be accepted. If a subcontract provides that the subcontractor is to be paid on the basis of cost of the work plus a fee, the subcontractor's cost of the work shall be determined in the same manner as Contractor's cost of the work. All subcontracts shall be subject to the other provisions of the contract documents insofar as applicable.
4. Costs of special consultants (including engineers, architects, testing laboratories, surveyors, and accountants) employed for services specifically, and only, related to the work.
5. Supplemental costs including the following:

- a. The proportion of necessary transportation, travel and subsistence expenses of Contractor's employees incurred in discharge of duties connected with the work.
- b. Cost, including transportation and maintenance, of all materials, supplies, equipment, machinery, appliances, office and temporary facilities at the site and hand tools not owned by the workers, which are consumed in the performance of the work, and cost, less market value of such items used but not consumed which remain the property of Contractor.
- c. Rentals of all construction equipment and machinery and the parts thereof whether rented from Contractor or others in accordance with rental agreements approved by County, and the costs of transportation, loading, unloading, installation, dismantling and removal thereof, all in accordance with terms of said rental agreements. The rental of any such equipment, machinery or parts shall cease when the use thereof is no longer necessary for the work.
- d. Sales, consumer, use, or similar taxes related to the work, and for which Contractor is liable, imposed by laws and regulations.
- e. Deposits lost for causes other than negligence of Contractor, any subcontractor or anyone directly or indirectly employed by any of them or for whose acts any of them may be liable, and royalty payments and fees for permits and licenses.
- f. Losses and damages (and related expenses), not compensated by insurance or otherwise, to the work or otherwise sustained by contractor in connection with the performance and furnishing of the work (except losses and damages within the deductible amounts of property insurance established by County), provided they have resulted from causes other than the negligence of Contractor, any subcontractor, or anyone directly or indirectly employed by any of them or for whose acts any of them may be liable. Such losses shall include settlements made with the written consent and approval of County. No such losses, damages and expenses shall be included in the cost of the work for the purpose of determining Contractor's fee. If, however, any such loss or damage requires reconstruction and Contractor is placed in charge thereof, Contractor shall be paid for services a fee proportionate to that stated below under Contractor's fee.
- g. The cost of utilities, fuel, and sanitary facilities at the site.
- h. Minor expenses such as telegrams, long distance telephone calls, telephone service at the site, expressage, and similar petty cash items in connection with the work.
- i. Cost of premiums for additional bonds and insurance required because of changes in the work and premiums for property insurance coverage within the limits of the deductible amounts established by County in this contract.

Not Included in Cost of the Work

The term "cost of the work" shall not include any of the following:

1. Payroll costs and other compensation of Contractor's officers, executives, principals (of partnership and sole proprietorships), general managers, engineers, architects, estimators, attorneys, auditors, accountants, purchasing and contracting agents, expeditors, timekeepers, clerks and other personnel employed by Contractor whether at the site or in Contractor's principal or a branch office for general administration of the work and not specifically included in the agreed upon schedule of job classifications referred to in this contract or specifically covered above under costs of special consultants, all of which are to be considered administrative costs covered by the Contractor's fee.
2. Expenses of Contractor's principal and branch offices other than Contractor's office at the site.
3. Any part of Contractor's capital expenses, including interest on Contractor's capital employed for the work and charges against Contractor for delinquent payments.
4. Cost of premiums for all bonds and for all insurance whether or not Contractor is required by the contract documents to purchase and maintain the same (except for the cost of premiums specifically covered above).

5. Costs due to the negligence of Contractor, any subcontractor, or anyone directly or indirectly employed by any of them or for whose acts any of them may be liable, including but not limited to, the correction of defective work, disposal of materials or equipment wrongly supplied and making good any damage to property.

6. Other overhead or general expense costs of any kind and the costs of any item not specifically and expressly included herein.

Contractor's Fee

The Contractor's fee allowed to Contractor for overhead and profit shall be determined by a fee based on the following percentages of the various portions of the cost of the work:

a. For all allowable costs of the work incurred under the paragraphs dealing with payrolled employees and costs of materials and equipment, the Contractor's fee shall be fifteen percent;

b. For all allowable costs of the work incurred under the paragraph dealing with work done by subcontractors, the Contractor's fee shall be five percent; and if a subcontract is on the basis of cost of the work plus a fee, the maximum allowable to Contractor on account of overhead and profit of all subcontractors shall be fifteen percent, for a total add-on of twenty percent.

c. No fee shall be payable on the basis of costs itemized under paragraphs dealing with special consultants, supplemental costs and/or costs not included in cost of the work.

d. The amount of credit to be allowed by Contractor to County for any such change which results in a net decrease in cost will be the amount of the actual net decrease plus a deduction in Contractor's fee by an amount equal to ten percent of the net decrease; and

e. When both additions and credits are involved in any one change, the adjustment in Contractor's fee shall be computed on the basis of the net change in accordance with paragraphs 2(a) through 2(d) above.

Cost Breakdown

Whenever the cost of any work is to be determined as set forth herein, Contractor will submit, in form acceptable to County, an itemized cost breakdown together with supporting data.

Cash Allowances

It is understood that Contractor has included in the contract price all allowances so named in the contract documents and shall cause the work so covered to be done by such subcontractors or suppliers and for such sums within the limit of the allowances as may be acceptable to County. Contractor agrees that:

1. The allowances include the cost to the Contractor (less any applicable trade discounts) of materials and equipment required by the allowances to be delivered at the site, and all applicable taxes; and

2. Contractor's cost for unloading and handling on the site, labor, installation costs, overhead, profit and other expenses contemplated for the allowances have been included in the contract price and not in the allowances. No demand for additional payment on account of any thereof will be valid.

Prior to final payment, an appropriate change order will be issued to reflect actual amounts due Contractor on account of work covered by allowances, and the contract price shall be correspondingly adjusted.

Unit Price Work

Where the contract documents provide that all or part of the work is to be unit price work, initially the contract price will be deemed to include for all unit price work an amount equal to the sum of the established unit prices for each separately identified item of unit price work times the estimated quantity of each item as indicated in the contract documents. The estimated quantities of items of unit price work are not guaranteed and are solely for the purpose of comparison of bids and determining an initial contract price. Determinations of the actual quantities and classifications of

unit price work performed by Contractor will be made by County. Each unit price will be deemed to include an amount considered by Contractor to be adequate to cover Contractor's overhead and profit for each separately identified item. Except for items shown on the bid sheet or in the specifications as "contingency" items where no additional amounts will be allowable, where the quantity of any item of unit price work performed by Contractor differs more than 25 percent from the estimated quantity of such item indicated in the contract documents and there is no corresponding adjustment with respect to any other item of work, and if either party believes that it has incurred additional expense or reduced cost as a result thereof, either party may make a claim for an increase or decrease in the contract price if the parties are unable to agree as to the amount of any such increase or decrease.

Final Pay Quantities

When the estimated quantities for a specific portion of the work are designated on the plans as final pay quantities, said estimated quantities shall be the final quantities for which payment for such specific portion of the work will be made, unless the dimensions of said portions of the work shown on the plans are revised by the Engineer. If such dimensions are revised, and such revisions result in an increase or decrease in the quantities of such work, the final quantities for payment will be revised in the amount represented by the changes in the dimensions. The estimated quantities for such specific portion of the work shall be considered as approximate only and no guarantee is made that the quantities which can be determined by computations, based on the details and dimensions shown on the plans, will equal the estimated quantities. No allowance will be made in the event that the quantities based on computations do not equal the estimated quantities.

When portions of an item have been designated on the plans as final pay quantities, portions not so designated will be measured and paid for in accordance with the applicable provisions of the Standard Specifications and Special Provisions.

In case of a discrepancy between the quantities shown on the plans as final pay quantities and the quantity of the same item shown in the Engineer's Estimate, payment will be based on the final pay quantities shown on the plans.

ARTICLE VII: PAYMENTS TO CONTRACTOR

Schedule of Values

The schedule of values established for the work will serve as the basis for progress payments and will be incorporated into a form of application for payment acceptable to County. Progress payments on account of unit price work will be based on the number of units completed.

Invoices

Invoices or applications for payment to the County shall be detailed and shall contain full documentation of all work performed and all reimbursable expenses incurred. Where the scope of work on the contract is divided into various tasks, invoices shall detail the related expenditures accordingly. Labor expenditures need documentation to support time, subsistence, travel, and field expenses. No expense will be reimbursed without adequate documentation. This documentation will include, but not be limited to, receipts for material purchases, rental equipment, and subcontractor work.

Progress Payment

Once each month County shall cause an estimate to be made covering the work completed as of the date of the estimate. No materials shall be paid for until incorporated into the work. If, however, County reaches an agreement with Contractor to pay for materials and equipment not yet incorporated into the work due to some special circumstances, then Contractor must show that the materials or equipment were delivered and are suitably stored at the site or at another location agreed to in writing. In that event, the payment shall be based on a bill of sale, invoice or other documentation submitted by Contractor and warranting that County has received the materials and equipment free and clear of all liens, charges, security interests and encumbrances (which are hereinafter referred to as "liens") and evidence that the materials and equipment are covered by appropriate property insurance and other arrangements to protect County's interest therein, all of

which will be satisfactory to County. The amount of retention with respect to progress payments will be five percent (5%).

Amounts of Progress Payments

Prior to completion, progress payments will be in an amount equal to:

1. Ninety five percent (95%) of the work completed, and
2. Where applicable pursuant to the above, ninety percent (90%) of materials and equipment not incorporated in the work but delivered and suitably stored, less in each case the aggregate of payments previously made.
3. Thirty-five days after recording of the Notice of Completion but not later than 60 days after completion of the work as defined in Public Contract Code Section 7107, and upon Contractor providing all required documentation, County will pay an amount sufficient to increase total payments to Contractor to one hundred percent (100%) of the contract price, less such amounts as County shall determine in accordance with this contract. County reserves the right to retain such funds as it shall determine in accordance with the contract documents to complete the work.
4. The Contractor may elect to receive 100% of payments due under this contract from time to time, without retention of any portion of the payment by the public agency, by depositing securities of equivalent value with County in accordance with the provisions of Section 22300 of the California Public Contract Code; except that no such substitution shall be allowed where federal money is funding the project and federal regulations or policies would prohibit such substitution of securities for the retention. Securities eligible for investment shall include those listed in Section 16430 of the California Government Code, or bank or savings and loan certificates of deposits. Such securities, if deposited by the bidder, shall be valued by County whose decision on the valuation of the securities shall be final. The bidder shall be the beneficial owner of any securities substituted for money withheld and shall receive any interest thereon.

Contractor's Warranty of Title

Contractor warrants and guarantees that title to all work, materials and equipment covered by any application for payment, whether incorporated in the project or not, will pass to County no later than the time of payment free and clear of all liens.

Payment of Progress Payment

County will submit each progress pay estimate to Contractor. Upon receipt back from Contractor of a signed copy of the pay estimate, County shall process the pay estimate for payment. The amount approved by County will become due thirty (30) days after receipt of the signed progress pay estimate. Said payment shall be made by County to Contractor unless County has knowledge of claims or liens filed in connection with the work.

Pursuant to Public Contract Code Section 20104.50, if the County fails to make any progress payment within thirty (30) days after receipt of an undisputed and properly submitted payment request it shall pay interest to Contractor at the legal rate set forth in subdivision (a) of Section 685.010 of the Code of Civil Procedure. "Progress payment" for purposes of this paragraph includes all payments due Contractor except that portion of the final payment designated by the contract as retention earnings.

Also, pursuant to Public Contract Code Section 20104.50, each payment request shall be reviewed by County as soon as practicable after receipt for the purpose of determining that the payment request is a proper payment request. Any payment request determined not to be a proper payment request suitable for payment shall be returned to Contractor as soon as practicable, but not later than seven (7) days after receipt. A request returned pursuant to this paragraph shall be accompanied by a document setting forth in writing the reasons why the payment request is not proper. The number of days available to County to make a payment without incurring interest pursuant to Public Contract Code Section 20104.50 shall be reduced by the number of days by which County exceeds the seven (7) day return requirement. A payment request shall be

considered properly executed if funds are available for payment of the payment request, and payment is not delayed due to an audit inquiry by the financial officer of the County.

County's Recommendation of Payment

By County's recommending any payment, Contractor cannot conclude that County represents that exhaustive or continuous on-site inspections have been made to check the quality or the quantity of the work in the contract documents or that there may not be other matters or issues between the parties that might entitle Contractor to be paid additionally by County or County to withhold payment to Contractor.

County May Refuse to Make Payment

County may refuse to make payment of the full amount or any part if, in County's opinion, it would be incorrect to make such payment. County may also refuse to make any such payment or, because of subsequently discovered evidence or the results of subsequent inspections or tests, nullify any such payment previously recommended, to such extent as may be necessary in County's opinion to protect County from loss because:

1. The work is defective, or completed work has been damaged requiring correction or replacement,
2. The contract price has been reduced by written amendment or change order,
3. Contractor has been required to correct defective work or complete work, or
4. Of County's actual knowledge of the occurrence of any of the events enumerated in paragraphs relating to suspension of work and termination.

County may refuse to make payment of the full amount because claims have been made against County on account of Contractor's performance or furnishing of the work or liens have been filed in connection with the work or there are other items entitling County to a set-off against the amount recommended, but County must give Contractor immediate written notice stating the reasons for such action.

Completion and Final Inspection

When Contractor considers the entire work ready for its intended use, Contractor shall notify County in writing that the entire work is completed. Within a reasonable time thereafter, County and Contractor shall make an inspection of the work to determine the status of completion. If County does not consider the work complete, County will notify Contractor in writing giving the reasons therefor. If County considers the work incomplete, County will prepare and deliver a list of items to be completed or corrected before final payment. Contractor shall immediately take such measures as are necessary to complete or correct the listed items.

Acceptance and Final Application for Payment

After Contractor has completed all such measures to remedy deficiencies to the satisfaction of County and delivered all maintenance and operating instructions, schedules, guarantees, bonds, certificates of inspection, marked-up record documents, property owner's releases and other documents, all as required by the contract documents, and after County has indicated that the work is acceptable, Contractor may make application for final payment. The final application for payment shall be accompanied by all documentation called for in the contract documents, together with complete and legally effective receipts, releases or waivers (satisfactory to County) from all subcontractors or material suppliers and an affidavit of Contractor that the releases and receipts include all labor, services, material and equipment for which a lien could be filed, and that all payrolls, material and equipment bills, and other indebtedness connected with the work for which County or County's property might in any way be responsible, have been paid or otherwise satisfied; and consent of the surety, if any, to final payment. If any subcontractor or supplier fails to furnish a release or receipt in full, or if a stop notice has been filed, Contractor may furnish a bond or other collateral satisfactory to County to indemnify County against any lien.

Final Payment

If, on the basis of County's review of the final application for payment and accompanying documentation, all as required by the contract documents, County is satisfied that Contractor's

obligations under the contract documents have been fulfilled, County will, within seven (7) days after receipt of the final application for payment, process the application for payment. Otherwise, County will return the application to Contractor, indicating in writing the reasons for refusing to make final payment, in which case Contractor shall make the necessary corrections and resubmit the application. Thirty-five days after presentation to County of the application and accompanying documentation, in appropriate form and substance, but no later than 60 days after completion of the project as defined in Public Contract Code Section 7107, or thirty-five (35) days after recording of a Notice of Completion, whichever date is later, the full retention will become due and will be paid by County to Contractor.

Delay in Completion Through No Fault of Contractor

If, through no fault of Contractor, final completion of the work is significantly delayed and if County so confirms, County shall, upon receipt of Contractor's final application for payment, and without terminating the Contract, make payment of the balance due for that portion of the work fully completed and accepted. If the remaining balance to be held by County for work not fully completed or corrected is less than the retainage stipulated in the contract, and if the appropriate bonds have been furnished, the written consent of the surety to the payment of the balance due for that portion of the work fully completed and accepted shall be submitted by Contractor to County with the application for such payment. Such payment shall be made under the terms and conditions governing final payment, except that it shall not constitute a waiver of claims.

Contractor's Continuing Obligation

Contractor's obligation to perform and complete the work in accordance with the contract documents shall be absolute. Neither the issuance of a certificate of substantial completion, nor any payment by County to Contractor under the contract documents, nor any use or occupancy of the work or any part thereof by County, nor any act of acceptance by County nor any failure to do so, nor any review and approval of a shop drawing or sample submission, nor the issuance of a notice of acceptability, nor any correction of defective work by County will constitute an acceptance of work not in accordance with the contract documents or a release of Contractor's obligation to perform the work in accordance with the contract documents.

Waiver of Claims

The making and acceptance of final payment will constitute:

1. A waiver of all claims by County against Contractor, except claims arising from unsettled liens, or from defective work appearing after final inspection or from failure to comply with the contract documents or the terms of any special guarantees specified therein, or from any outstanding claims; however, it will not constitute a waiver by County of any rights in respect of Contractor's continuing obligations under the contract documents; and
2. A waiver of all claims by Contractor against County other than those previously made in writing and still unsettled.

Books of Account and Audit Provision

Contractor shall maintain on a current basis complete books and records relating to this contract. Such records shall include, but not be limited to, documents supporting all bids, all income, and all expenditures. The books and records shall be original entry books with a general ledger itemizing all debits and credits for the work on this contract. In addition, Contractor shall maintain detailed payroll records including all subsistence, travel and field expenses, and canceled checks, receipts, and invoices for all items. These documents and records shall be retained for at least five years from the completion of this contract. Contractor will permit County to audit all books, accounts or records relating to this contract or all books, accounts or records of any business entities controlled by Contractor who participated in this contract in any way. Any audit may be conducted on Contractor's premises, or, at County's option, Contractor shall provide all books and records within a maximum of fifteen (15) days upon receipt of written notice from County. Contractor shall refund any moneys erroneously charged. If County ascertains that it has been billed erroneously by Contractor for an amount equaling 5% or more of the original bid, Contractor shall be liable for the costs of the audit in addition to any other penalty to be imposed.

ARTICLE VIII: PRELIMINARY MATTERS

Delivery of Certificates of Insurance

Before any work at the site is started, Contractor shall deliver to County certificates (and other evidence of insurance requested by County) which Contractor is required to purchase and maintain in accordance with the insurance provisions herein.

Delivery of Bonds

When Contractor delivers the executed Agreements to County, Contractor shall also deliver to County the bonds required herein. Notwithstanding the language in bonds authorizing attorneys' fees to be awarded if suit is brought upon the bond, no attorneys' fees shall be payable for any other suit brought under this contract.

Pre-construction Conference

Within **7 days** after receipt of the notice to proceed, but before contractor starts the work at the site, a conference attended by Contractor and County and others as appropriate will be held to discuss schedules, procedures for handling shop drawings and other submittals and for processing applications for payment, and to establish a working understanding among the parties as to the work.

Delivery of Schedules

Within **5 days** after receipt of written notice to proceed, Contractor shall submit to County for review:

1. An estimated progress schedule indicating the starting and completion dates of the various stages of the work;
2. A preliminary schedule of shop drawing submissions;
3. A preliminary schedule of product deliveries;
4. A preliminary schedule of values for all of the work which will include quantities and prices of items aggregating the contract price and will subdivide the work into component parts in sufficient detail to serve as the basis for progress payments during construction. Such prices will include an appropriate amount of overhead and profit applicable to each item of work which will be confirmed in writing by Contractor at the time of submission.

Finalizing Schedules

At least ten days before submission of the first application for payment a conference attended by Contractor, County, and others as appropriate will be held to finalize schedules. The finalized progress schedule will be acceptable to County as providing an orderly progression of the work to completion within the contract time, but such acceptance will neither impose on County responsibility for the progress or scheduling of the work nor relieve Contractor from full responsibility therefor. The finalized schedule of shop drawing submissions will be acceptable to County as providing a workable arrangement for processing the submissions. The finalized schedule of values will be acceptable to County as to form and substance.

Before Starting Construction

Contractor shall provide County with at least 72 hours written notice of the date on which it intends to commence work. Before undertaking each and every part of the work, Contractor shall carefully study and compare the contract documents and check and verify pertinent figures shown thereon and all applicable field measurements. Contractor shall promptly report in writing to County any conflict, error, or discrepancy which Contractor may discover and shall obtain a written interpretation or clarification from County before proceeding with any work affected thereby; however, Contractor shall not be liable to County for failure to report any conflict, error, or discrepancy in the contract documents, unless Contractor had actual knowledge thereof or should reasonably have known thereof.

Contractor's Representations

In order to induce County to enter into this agreement, Contractor makes the following representations:

1. Contractor has familiarized himself or herself with the nature and extent of the contract documents, work, locality, and with all local conditions and federal, state, and local laws, ordinances, rules, and regulations that in any manner may affect cost, progress, or performance of the work.
2. Contractor has studied carefully all reports of investigations and tests of subsurface and latent physical conditions at the site or otherwise affecting cost, progress or performance of the work which were relied upon by County in the preparation of the drawings and specifications and which have been identified in the contract documents.
3. Contractor has made or caused to be made examinations, investigations, and tests and studies of such reports and related data necessary for the performance of the work at the contract price, within the contract time and in accordance with the other terms and conditions of the contract documents; and no additional examinations, investigations, tests, reports, or similar data are or will be required by Contractor for such purposes.
4. Contractor has correlated the results of all such observations, examinations, investigations, tests, reports and data with the terms and conditions of the contract documents.
5. Contractor has given County written notice of all conflicts, errors or discrepancies that have been discovered in the contract documents and the written resolution thereof by County is acceptable to Contractor.

ARTICLE IX: CHANGES IN THE WORK

County May Order Changes

Without invalidating this contract and without notice to any surety, County may, at any time or from time to time, order additions, deletions, or revisions in the work; these will be authorized by change order. Upon receipt of any such document, Contractor shall promptly forward any request for change in the contract price and, if instructed to do so, proceed with the work involved which will be performed under the applicable conditions of the contract documents (except as otherwise specifically provided).

Failure to Agree to a Price or Time Change, Claims

If County and Contractor are unable to agree as to the extent, if any, of an increase or decrease in the contract price or an extension or shortening of the contract time that should be allowed, a claim may be made therefor but the work shall proceed if County so instructs.

No Change in Time or Price for Work Not Required

Contractor shall not be entitled to an increase in the contract price or an extension of the contract time with respect to any work performed that is not required by the contract documents as amended, modified, and supplemented except in the case of an emergency as set forth herein and except in the case of uncovering work for inspection or testing as set forth in this contract.

Changes in Time or Price

County and Contractor shall execute appropriate change orders (or written amendments) covering:

1. Changes in the work which are ordered by County or are agreed to by the parties;
2. Changes in the contract price or contract time which are agreed to by the parties; and
3. Changes in the contract price or contract time which embody the substance of any written decision rendered by County in response to a request therefor.

Notice to Sureties

If notice of any change affecting the general scope of the work or the provisions of the contract documents (including, but not limited to, contract price or contract time) is required by the provisions of any bond to be given to a surety, the giving of any such notice will be Contractor's responsibility, and the amount of each applicable bond will be adjusted accordingly. Failure to give such notice shall not release the surety from its obligations to County.

ARTICLE X: CONTRACT DOCUMENTS

Intent

The contract documents comprise the entire agreement between County and Contractor concerning the work. The contract documents are complementary; what is called for by one is as binding as if called for by all. The contract documents will be construed in accordance with California law.

Contract Interpretation

It is the intent of the contract documents to describe a functionally complete project (or part thereof) to be constructed in accordance with the contract documents. Any work, materials or equipment that may reasonably be inferred from the contract documents as being required to produce the intended results will be supplied whether or not specifically called for. When words which have a well-known technical or trade meaning are used to describe work, materials or equipment, such words shall be interpreted in accordance with that meaning. Reference to standard specifications, manuals, or codes of any technical society, organization, or association, or to the laws or regulations of any governmental authority, whether such reference be specific or by implication, shall mean the latest standard specification, manual, code or laws or regulations in effect at the time of opening of bids, except as may be otherwise specifically stated. However, no provision of any referenced standard specification, manual or code (whether or not specifically incorporated by reference in the contract documents) shall be effective to change the duties and responsibilities of County or Contractor, or any of their consultants, agents or employees from those set forth in the contract documents, nor shall it be effective to assign to County, or any of County's consultants, agents or employees, any duty or authority to supervise or direct the furnishing or performance of the work or any duty or authority to undertake responsibility contrary to the provisions of this contract. Clarifications and interpretations of the contract documents shall be issued by County.

Conflicts, Errors and Discrepancies

If during the performance of the work, Contractor finds a conflict, error or discrepancy in the contract documents, Contractor shall so report to County in writing at once and before proceeding with the work affected thereby shall obtain a written interpretation or clarification from County.

Amending Contract Documents

The contract documents may be amended to provide for additions, deletions, and revisions in the work or to modify the terms and conditions thereof by change order. Contract price and contract time may only be changed by change order.

Supplementary Contract Documents

In addition to the above, the requirements of the contract documents may be supplemented, and minor variations and deviations in the work may be authorized in one or more of the following ways:

1. A field order,
2. County's approval of a shop drawing or sample, or
3. County's written interpretation or clarification.

Reuse of Documents

Neither contractor nor any subcontractor or supplier or other person or organization performing or furnishing any of the work under a direct or indirect contract with County shall have or acquire any title to or ownership rights in any of the drawings, specifications or other documents (or copies of any thereof) prepared by or bearing the seal of County; and they shall not reuse any of them on extensions of the project or any other project without written consent of County and specific written verification or adaptation by County.

Contract Documents

The contract documents comprise the entire agreement between the parties and may be amended only by writing signed by both parties or by written change order. The contract documents shall include this contract, any general and special conditions, plans and specifications, bidding documents and addenda thereto, and all bids submitted by Contractor.

A component in one Contract part applies as if appearing in each. The parts are complementary and describe and provide for a complete work.

In the case of ambiguity or conflict, the documents shall be given the following priority:

1. Governing ranking of Contract parts in descending order is:
 - 1.1. Contract
 - 1.2. Instructions to Bidders, including addendums
 - 1.3. Project Special Provisions
 - 1.4. Project plans
 - 1.5. Revised standard specifications
 - 1.6. Standard specifications
 - 1.7. Revised standard plans
 - 1.8. Standard plans
 - 1.9. Supplemental project information
 - 1.10. Nevada County Road Standards and Nevada County Standard Road Drawings
2. Written numbers and notes on a drawing govern over graphics
3. Detail drawing governs over a general drawing
4. Specific specification governs over a general specification
5. Specification in a section governs over a specification referenced by that section

If a discrepancy is found or confusion arises, submit an RFI.

ARTICLE XI: THE PROJECT SITE

Availability of Lands

County shall furnish, as indicated in the contract documents, the lands upon which the work is to be performed, rights-of-way and easements for access thereto, and such other lands which are designated for the use of Contractor. Easements for permanent structures or permanent changes in existing facilities will be obtained and paid for by County, unless otherwise provided in the contract documents. If Contractor believes that any delay in County's furnishing these lands, rights-of-way or easements entitles Contractor to an extension of the contract time, Contractor may make a claim therefor as provided for herein. Contractor shall provide for all additional lands and access thereto that may be required for temporary construction facilities or storage of materials and equipment.

Physical Conditions

If the contract documents identify those reports of explorations and tests of subsurface conditions at the site that have been utilized by County in preparation of the contract documents, Contractor may rely upon the accuracy of the factual data contained in such reports but not upon interpretations or opinions contained therein or for the completeness or representativeness thereof for Contractor's purposes. If construction drawings of physical conditions in or relating to existing surface and subsurface structures (except underground facilities discussed below) at or contiguous to the site have been utilized by County in preparation of the contract documents, Contractor may rely upon the accuracy of the factual data contained in such drawings but not the completeness thereof for Contractor's purposes. If Contractor believes that any factual data on which Contractor is entitled to rely is inaccurate, or any physical condition uncovered or revealed at the site differs materially from that indicated, reflected, or referred to in the contract documents, Contractor shall, promptly after becoming aware thereof and before performing any work in connection therewith (except in an emergency as permitted herein), notify County in writing about the inaccuracy or difference. Failure to notify County promptly shall relieve County of any liability for any and all claims resulting from such inaccuracy or difference.

County's Review

County will review the pertinent conditions, determine the necessity of obtaining additional explorations or tests with respect thereto and advise Contractor in writing of County's findings and conclusions.

Possible Document Change

If County concludes that there is a material error in the contract documents or that because of newly discovered conditions a change in the contract documents is required, a change order will be issued in writing as provided to reflect and document the consequences of the inaccuracy or difference.

Possible Price and Time Adjustments

In each case of inaccuracy or difference, an increase or decrease in the contract price or an extension or shortening of the contract time, or any combination thereof, will be allowable to the extent that they are attributable to any such inaccuracy or difference. If County and Contractor are unable to agree as to the amount or length thereof, a claim may be made therefor as provided in the contract documents.

Physical Conditions - Underground Facilities

The information and data shown or indicated in the contract documents with respect to existing underground facilities at or contiguous to the site is based on information and data furnished to County by the owners of such underground facilities or by others. Generally service connections are not indicated on drawings. Unless it is otherwise expressly provided:

1. County shall not be responsible for the accuracy or completeness of any such information or data; and,
2. Contractor shall have full responsibility for reviewing and checking all such information and data, for locating all underground facilities shown or indicated in the contract documents, for coordination of the work with the owners of such underground facilities during construction, for the safety and protection thereof, and repairing any damage thereto resulting from the work, the cost of all of which will be considered as having been included in the contract price.
3. If an underground facility is uncovered or revealed at or contiguous to the site which was not shown or indicated in the contract documents and which Contractor could not reasonably have been expected to be aware of, Contractor shall, promptly after becoming aware thereof and before performing any work affected thereby (except in an emergency as permitted by this contract), identify the owner of such underground facility and give written notice thereof to that owner and to County. County will review the underground facility to determine the extent to which the contract documents should be modified to reflect and document the consequences of the existence of the underground facility, and the contract documents will be amended or supplemented to the extent necessary. During such time, Contractor shall be responsible for the safety and protection of such underground facility as provided herein. Contractor shall be allowed an increase in the contract price or an extension of the contract time, or both, to the extent that they are attributable to the existence of any underground facility that was not shown or indicated in the contract documents and which Contractor could not reasonably have been expected to be aware of and will not be assessed liquidated damages pursuant to Government Code Section 4215. If the parties are unable to agree as to the amount or length thereof, Contractor may make a claim therefor as provided in these contract documents.

Preservation of Property

Due care shall be exercised to avoid injury to existing highway improvements or facilities, utility facilities, adjacent property, and roadside trees, shrubs, and other plants that are not to be removed. Roadside trees, shrubs, and other plants that are not to be removed, and pole lines, fences, signs, markers and monuments, buildings and structures, conduits, pipelines under or above ground, sewer and water lines, all highway facilities and any other improvements or facilities within or adjacent to the project shall be protected from injury or damage, and if ordered by County, the Contractor shall provide and install suitable safeguards, approved by County, to protect such objects from injury or damage. If such objects are injured or damaged by reason of the Contractor's operations, they shall be replaced or restored at the Contractor's expense. The facilities shall be replaced or restored to a condition as good as when the Contractor entered upon the work, or as

good as required by the specifications accompanying the contract, if any such objects are a part of the work being performed under the contract. County may make or cause to be made such temporary repairs as are necessary to restore to service any damaged facility. The cost of such repairs shall be borne by the Contractor and may be deducted from any moneys due or to become due to the Contractor under the contract. Full compensation for furnishing all labor, materials, tools, equipment, and incidentals, and for doing all the work involved in protecting or repairing property, shall be considered as included in the prices paid for the various contract items of work and no additional compensation will be allowed therefor.

Reference Points

County shall establish one or more horizontal and vertical reference points for construction which in County's judgment are necessary to enable Contractor to proceed with the work or as provided in the contract documents. County shall set any other stakes or marks which it deems necessary to establish the lines and grades required for the completion of the work unless the Special Provisions require that the Contractor is responsible for laying out the work. Contractor shall notify the County when Contractor requires staking, in writing a reasonable time in advance of such requirement. In no event shall Contractor give less than two working days notice of such requirement. Contractor shall protect and preserve the established reference points, stakes and marks and shall make no changes or relocations without the prior written approval of County. Contractor shall report to County whenever any reference point, stake or mark is lost or destroyed or requires relocation because of necessary changes in grades or locations. Contractor will be charged for the cost of relocation or replacement if the need therefor arises due to Contractor's acts.

Power

The Contractor shall provide, at no additional cost to the County, all construction power used at the project site and shall make all arrangements with the electrical utility and with the County for power takeoff points, voltage and phasing requirements, transformers, and metering and shall pay all costs and fees arising therefrom. It shall be the Contractor's responsibility to provide all special connections required for the work.

Water

The Contractor shall provide the water needed for the work, including potable water, construction water, and water for testing purposes.

Sanitary Facilities

The Contractor shall make arrangements for use of adequate toilet facilities at or near the site of work. Such facilities shall be subject to the acceptance of the County as to location and type. The Contractor shall maintain the sanitary facilities in acceptable condition from the beginning of the work until completion and shall remove the facilities and disinfect the premises.

ARTICLE XII: PAYMENT AND PERFORMANCE BONDS

Bonds to be Provided

The Contractor shall furnish two bonds each in the amount of one hundred (100%) percent of the contract price, one as security for the faithful performance of the work, and the other as security for the faithful payment and satisfaction of all persons furnishing materials and performing labor for the project. The bonds shall be issued by a corporation duly and legally licensed to transact surety business in the State of California. The payment bond shall remain in force throughout the period required to complete the work and for 35 days after the recording of the Notice of Completion. The performance bond shall remain in force for a period of 365 days after final acceptance of the work to cover any defects in workmanship, materials, or equipment which develop in that time. The bonds must be executed by a duly licensed surety company and accompanied by a certified copy of the authority to act. The scope of the bonds or the forms thereof shall in no way affect or alter the liabilities of the Contractor to County. Bonds shall be executed on the forms included in the contract documents.

Insolvency or Termination of Right to Do Business

If the surety on any bond furnished by Contractor is declared bankrupt or becomes insolvent or its right to do business is terminated in California, Contractor shall within five days thereafter substitute another bond and surety, both of which must be acceptable to County. If an acceptable substitute is not furnished within five days, County may terminate Contractor.

ARTICLE XIII: CONTRACTOR LIABILITY AND INSURANCE

Liability of Contractor

The Contractor shall be liable for all damages and injury which shall be caused to County or any other owners of property on or in the vicinity of the work or which shall occur to any person or persons or property whatsoever arising out of the performance of this contract. Contractor agrees to hold County harmless and indemnify County for any such losses.

Contractor's Liability Insurance

Contractor shall purchase and maintain commercial general liability and other insurance as is appropriate for the work being performed and furnished and as will provide protection from claims set forth below which may arise out of or result from Contractor's performance and furnishing of the work and Contractor's other obligations under the contract documents, whether it is to be performed or furnished by Contractor, by any subcontractor, by anyone directly or indirectly employed by any of them to perform or furnish any of the work, or by anyone for whose acts any of them may be liable:

1. Claims under workers' disability benefits and other similar employee benefit acts;
2. Claims for damages because of bodily injury, occupational sickness or disease, or death of Contractor's employees;
3. Claims for damages because of bodily injury, sickness or disease, or death of any person other than Contractor's employees;
4. Claims for damages insured by personal injury liability coverage which are sustained (a) by any person as a result of an offense directly or indirectly related to the employment of such person by Contractor, or (b) by any other person for any other reason;
5. Claims for damages, other than to the work itself, because of injury to or destruction of tangible property wherever located, including loss of use resulting therefrom;
6. Claims arising out of operation of laws or regulations for damages because of bodily injury or death of any person or for damage to property; and
7. Claims for damages because of bodily injury or death of any person or property damage arising out of the ownership, maintenance or use of any motor vehicle.

To the extent that Contractor's work, or work under Contractor's direction, may require blasting, explosive conditions, or underground operations, the comprehensive general liability coverage shall contain no exclusion relative to blasting, explosion, collapse of buildings, or damage to underground property.

The insurance required by this paragraph shall be "per occurrence" coverage and shall include the specific coverages and be written for not less than the limits of liability and coverages provided herein, or required by law, whichever is greater. The commercial general liability insurance shall include completed operations insurance. All such insurance shall remain in effect until final payment and at all times thereafter when Contractor may be correcting, removing, or replacing defective work. In addition, Contractor shall maintain such completed operations insurance for at least one year after final payment and furnish County with evidence of continuation of such insurance at final payment. If Contractor's insurance is canceled prior to completion of the project and the Contractor does not furnish a new Certificate of Insurance prior to cancellation, County may obtain the required insurance and deduct the premium from contract moneys due the Contractor.

At the option of Contractor, evidence of coverage and limits may be furnished by an umbrella liability policy certificate in addition to certificates for worker's compensation and employer's liability, and comprehensive automobile and general liability policies.

Contractual Liability Insurance

The commercial general liability insurance required above will include contractual liability insurance applicable to Contractor's obligations hereunder.

Property Insurance

Unless otherwise specifically provided, Contractor shall purchase and maintain property insurance (builder's risk) upon the work or equipment and supplies stored at the site to the full insurable value thereof (subject to such deductible amounts as may be agreed upon or required by laws and regulations.) This insurance shall include the interests of County and its agents, Contractor, and subcontractors in the work. County shall be listed as an additional insured party. Said policy shall insure against the perils of fire, extended coverage, testing and shall include "all risk" insurance for physical loss and damage including theft, vandalism and malicious mischief, collapse and water damage, and such other perils as may be provided herein, and shall include damages, losses and expenses arising out of or resulting from any insured loss or incurred in the repair or replacement of any insured property (including but not limited to fees and charges of engineers, architects, attorneys and other professionals).

Amount of Property Insurance

Said insurance shall be on a "per occurrence" basis for the full value of the work and supplies and equipment stored or used in connection with the project and shall include vandalism and malicious mischief endorsement. Special consent of County shall be required prior to use of "claims made" coverage.

Schedule of Required Insurance

1. Worker's Compensation Insurance: Statutory amount and employer's liability of **\$1,000,000**.
2. Contractor's Commercial General Liability Insurance (bodily injury, property damage and including contractual liability insurance, completed operations and products liability insurance): **\$2,000,000**.
3. Comprehensive Business or Commercial Automobile Liability Coverage (bodily injury liability, property damage liability, uninsured motorist protection and including non-owned and hired automobile liability): **\$2,000,000**.

Nevada County shall be named as additional insured on all insurance policies. Contractor shall provide proof of insurance required in this contract evidenced by certificates of insurance and endorsements.

Notice Requirement

All the policies of insurance (or the certificates or other evidence thereof) required to be purchased and maintained by the Contractor shall contain a provision or endorsement that the coverage afforded will not be canceled, materially changed, or renewal refused until at least ten (10) days prior written notice has been given to County by registered mail.

Deductibles and Self-Insured Retentions

Any deductibles or self-insured retentions must be fully disclosed by Contractor and approved by County prior to commencement of work. At County's option, the insurer shall reduce or eliminate such deductibles or self-insured retentions as respects County, its officials and employees, or Contractor shall provide a bond guaranteeing payment of losses and related investigations, claims administration and defense expenses.

Risk of Loss

Liability for loss or damage to equipment, materials, workmanship, or services occurring on or off the site shall be the responsibility of the Contractor. Liability for completed work shall not be assumed by County until both the work has been completed and County has accepted the work as complete. County will not be responsible for purchasing and maintaining any property insurance to

protect the interests of Contractor, subcontractors, or others in the work. The risk of loss will be borne by Contractor, subcontractor or others suffering any such loss and if any of them wishes property insurance coverage in addition to insurance required herein, each may purchase and maintain it at the purchaser's own expense.

Waiver of Rights

Contractor waives all rights against County and its agents for all losses and damages caused by any of the perils covered by the policies of insurance provided for above and any other property insurance applicable to the work, and all other parties named as insureds in such policies for losses and damages so caused. Each subcontract between Contractor and a subcontractor will contain similar waiver provisions by the subcontractor in favor of County and its agents and all other parties named as insureds. None of the above waivers shall extend to the rights that any of the insured parties may have to the proceeds of insurance held by County as trustee or otherwise payable under any policy so issued.

No Right of Recovery

County and Contractor intend that any policies provided as set forth herein shall protect all of the parties insured and provide primary coverage for all losses and damages caused by the perils covered thereby. Any insurance or self-insurance maintained by County shall be in excess of Contractor's insurance and shall not contribute to it.

Receipt and Application of Proceeds

Any insured loss under the policies of insurance required herein will be adjusted with County and made payable to County as trustee for the insureds, as their interests may appear, subject to the requirements of any applicable mortgage clause. County shall deposit in a separate account any money so received, and shall distribute it in accordance with such agreement as the parties in interest may reach. If no other special agreement is reached, the damaged work shall be repaired or replaced, the moneys so received applied on account thereof and the work and the cost thereof covered by an appropriate change order or written amendment.

County's Duties as Trustee

County as trustee shall have power to adjust and settle any loss with the insurers.

Acceptance of Insurance

If County has any objection to the coverage afforded by or other provisions of the insurance required to be purchased and maintained by Contractor on the basis of its not complying with the contract documents, County shall notify Contractor in writing thereof and Contractor shall immediately provide proof of the proper coverage. Contractor shall provide to County such additional information in respect of insurance provided by it as County may reasonably request. County may at its option waive any type of insurance required herein which County in its discretion deems to be inapplicable to the type of project being constructed. Any such waiver shall be in writing by the County Administrator.

Verification of Coverage

Contractor shall furnish County with certificates of insurance and with original endorsements affecting coverage required by this clause. The certificates and endorsements for each insurance policy are to be signed by a person authorized by that insurer to bind coverage on its behalf. The certificates and endorsements are to be on forms provided by County and are to be received and approved by County before work commences.

Subcontractors

Contractor shall include all subcontractors as insureds under its policies or shall furnish separate certificates and endorsements for each subcontractor. All coverages for subcontractors shall be subject to all of the requirements stated herein.

ARTICLE XIV: MATERIALS AND EQUIPMENT

Material and Equipment

Unless otherwise specified, Contractor shall furnish and assume full responsibility and risk of loss for all materials, equipment, labor, transportation, construction equipment and machinery, tools, appliances, fuel, power, light, heat, telephone, water, sanitary facilities, temporary facilities and all other facilities and incidentals necessary for the furnishing, performance, testing, start-up, and completion of the work.

Quality of Materials and Equipment

All materials and equipment shall be of good quality and new, except as otherwise provided in the contract documents. If required by County, Contractor shall furnish satisfactory evidence (including reports of required tests) as to the kind and quality of materials and equipment. Contractor may be required to show that materials and/or equipment will be available in sufficient quantity or time so as to assure top quality performance of the contract. All materials and equipment shall be applied, installed, connected, erected, used, cleaned and conditioned in accordance with the instructions of the applicable supplier except as otherwise provided in the contract documents; but no provision of any such instructions will be effective to assign to County, or any of County's consultants, agents or employees, any duty or authority to supervise or direct the furnishing or performance of the work or any duty or authority to undertake responsibility contrary to the provisions of this contract.

Storage of Materials and Equipment

Materials and equipment shall be stored where specified by County and so as to insure the preservation of their quality and fitness for the work. Stored equipment and materials shall be located so as to facilitate inspection. The Contractor shall be responsible for all damages that occur to materials and equipment until the completion and final acceptance of the work by the County.

Substitute Items

Whenever materials or equipment are specified or described in the contract documents by using the name of a proprietary item or the name of a particular supplier the naming of the item is intended to establish the type, function and quality required. Unless the name is followed by words indicating that no substitution is permitted, materials or equipment of other suppliers may be accepted by County if sufficient information is submitted in advance by Contractor to allow County to determine that the material or equipment proposed is equivalent or equal to that named.

The procedure for review by County will include the following: requirements for review of substitute items of material and equipment or modification or alteration of the design of any material or equipment or portion of the work will not be accepted by County from anyone other than Contractor. If Contractor wishes to furnish or use a substitute item of material or equipment or modification or alteration of the design of any material or equipment or portion of the work, Contractor shall make written application to County for acceptance thereof, certifying that the proposed substitute or modification or alteration will perform adequately the functions and achieve the results called for by the general design, be similar and of equal substance to that specified and be suited to the same use as that specified. The application will state that the evaluation and acceptance of the proposed substitute will not prejudice Contractor's achievement of completion on time, whether or not acceptance of the substitute or design modification or alteration for use in the work will require a change in any of the contract documents (or in the provisions of any other direct contract with County for work on the project) to adapt the design to the proposed substitute or design modification or alteration and whether or not incorporation or use of the substitute in connection with the work is subject to payment of any license fee or royalty. All variations of the proposed substitute or design modification or alteration from that specified will be identified in the application and available maintenance, repair and replacement service will be indicated, where necessary. The application will also contain an itemized estimate of all costs that will result directly or indirectly from acceptance of such substitute or design modification or alteration, including costs of redesign and claims of other contractors affected by the resulting change, all of which shall be considered by County in evaluating the proposed substitute or design modification or alteration. County may require Contractor to furnish at Contractor's expense additional data about the proposed substitute

or design modification or alteration. County will be allowed a reasonable time within which to evaluate each proposed substitute or design modification or alteration. County will be the sole judge of acceptability, and no substitute or design modification or alteration will be ordered, installed, or utilized without County's prior written acceptance which will be evidenced by either a change order or an accepted shop drawing. County may require Contractor to furnish at Contractor's expense a special performance guarantee or other surety with respect to any substitute or design modification or alteration. Contractor shall pay all costs for redesign required by the implementation of the proposed substitute.

Operating and Maintenance Instructions and Manufacturer's Warranties

Before receiving payment for more than 60 percent of the purchase value of any equipment and prior to installation of said equipment, the Contractor shall deliver to County acceptable manufacturer's operating and maintenance instructions covering each item of equipment assembly provided under this contract and each and every warranty provided by the manufacturer. Manufacturers' standard brochures or manuals will be modified to reflect only that model or series of equipment installed on this project. All extraneous material will be crossed out or otherwise altered as acceptable to County.

The operating and maintenance instructions shall include, as a minimum, the following data for each item of mechanical, electrical, and instrumentation equipment:

1. An itemized list of all data provided.
2. Name and location of the manufacturer, the manufacturer's local representative, the nearest supplier and spare parts warehouse.
3. Accepted submittal information applicable to operation and maintenance.
4. Recommended installation, adjustment, start up, calibration, and troubleshooting procedures.
5. Recommended lubrication and an estimate of yearly quantity needed.
6. Recommended step-by-step procedures for all modes of operation.
7. Complete internal and connection wiring diagrams.
8. Recommended preventive maintenance procedures and schedule.
9. Complete parts lists, by generic title and identification number, with exploded view of each assembly.
10. Recommended spare parts.
11. Disassembly, overhaul, and re-assembly instructions.
12. Complete, as applicable, operating and maintenance instructions, transmittal forms and summary sheets.
13. Nameplate data for all equipment supplied, including make, model and serial numbers, type, and motor data together with designation and location of equipment.

Before final acceptance of the project, the Contractor shall bind all of the above in an appropriately labeled binder. Each completed binder shall contain only that material which can be held in a non-expanded position. A complete table of contents listing all items and their location in the set shall be included in each binder. For ready reference, the Contractor shall compile a complete list of manufacturer's local representatives for each item provided. In addition to withholding payment where Contractor fails to provide County with manufacturer's warranties, Contractor shall also be deemed to have personally warranted the equipment to the same extent as the manufacturer's warranty on the equipment.

Patent Fees and Royalties

Contractor shall pay all license fees and royalties and assume all costs incident to the use in the performance of the work or the incorporation in the work of any invention, design, process, product, or device which is the subject of patent rights or copyrights held by others. If a particular invention, design, process, product, or device is specified in the contract documents for use in the performance of the work and if to the actual knowledge of County its use is subject to patent rights

or copyrights calling for the payment of any license fee or royalty to others, the existence of such rights shall be disclosed by County in the contract documents. Contractor shall indemnify and hold harmless County and anyone directly or indirectly employed by either of them from and against all claims, damages, losses and expenses (including attorneys' fees and court and arbitration costs) arising out of any infringement of patent rights or copyrights incident to the use in the performance of the work or resulting from the incorporation in the work of any invention, design, process, product or device not specified in the contract documents, and shall defend all such claims in connection with any alleged infringement of such rights.

Contractor's Equipment

The Contractor shall identify each piece of Contractor's equipment, other than hand tools, by means of an identifying number plainly stenciled or stamped on the equipment at a conspicuous location, and shall furnish to County a list giving the description of each piece of equipment and its identifying number. In addition, the make, model number and empty gross weight of each unit of compacting equipment shall be plainly stamped or stenciled in a conspicuous place on the unit. The gross weight shall be either the manufacturer's rated weight or the scale weight.

The make, model, serial number, and manufacturer's rated capacity for each scale shall be clearly stamped or stenciled on the load receiving element and its indicator or indicators. All meters shall be similarly identified, rated, and marked. Upon request of County, the Contractor shall furnish a statement by the manufacturer, designating sectional and weighbridge capacities of portable vehicle scales.

ARTICLE XV: PLANS AND SPECIFICATIONS

Interpretation of Plans, Specifications and Drawings

The plans, specifications and the drawings are intended to be explanatory of each other. Any work indicated on the drawings and not in the plans or specifications, or vice versa, shall be executed as if indicated in both. Where not specifically stated otherwise, all work and materials necessary for each unit of construction, including special construction for any specific brand or shape of material called for even though only briefly mentioned or indicated, shall be furnished, and installed fully and completely as a part of the Contract. As the figured dimensions shown on the drawings and in the specifications of the contract may not in every case agree with scale dimensions, the figured dimensions shall be followed in preference to the scaled dimensions. Should it appear that the work to be done, or any of the matters relative thereto are not sufficiently detailed or explained in the contract documents, the Contractor shall apply to County for such further explanations as may be necessary, and shall conform thereto as part of the contract so far as may be consistent with the terms thereof. In the event of any doubt or question arising respecting the true meanings of the plans, specifications or drawings, the decision of County shall be final and conclusive.

Where for convenience the specifications are arranged by job classification or divided into various sections, it is to be understood this separation is for the convenience of all parties involved and is not to be considered as the limits of the work required of any separate trade. The terms and conditions of such limitations are wholly between Contractor and its subcontractors during both the bidding and construction phase, i.e., all work shown, specified, implied or necessary for the completion of each trade's work, as well as for the proper completion of the project as a whole shall be coordinated by Contractor and the subcontractors during bidding and construction and shall be provided in this contract.

Ownership

All plans and specifications shall remain the property of County and shall be returned to County before the final certificate will be issued.

Handicapped Access

Where applicable, it is the County's intent for all features on the plans and specifications to conform to applicable regulations for the accommodation of physically handicapped persons in buildings and facilities used by the public.

ARTICLE XVI: SHOP DRAWINGS AND SAMPLES

Shop Drawings

After checking and verifying all field measurements and after complying with applicable procedures herein, Contractor shall submit to County for review and acceptance in accordance with the accepted schedule of shop drawing submissions or other appropriate action if so indicated herein, the number of copies specified of all shop drawings, which will bear a stamp or specific written indication that Contractor has satisfied Contractor's responsibilities under the contract documents with respect to the review of the submission. All submissions will be identified as County may require. Such drawings shall be approved by County before any work involving the drawings is performed. The data shown on the shop drawings will be complete with respect to quantities, dimensions, specified performance and design criteria, materials, and similar data to enable County to review the information as required.

Samples

Contractor shall also submit to County for review and acceptance with such promptness as to cause no delay in work, all samples required by the contract documents or as requested by County. All samples will have been checked by and accompanied by a specific written indication that Contractor has satisfied Contractor's responsibilities under the contract documents with respect to the review of the submission and will be identified clearly as to material, supplier, pertinent data such as catalog numbers and the use for which intended.

Contractor's Review

Before submission of each shop drawing or sample, Contractor shall have determined and verified all quantities, dimensions, specified performance criteria, installation requirements, materials, catalog numbers and similar data with respect thereto and reviewed or coordinated each shop drawing or sample with other shop drawings and samples and with the requirements of the work and the contract documents.

Notice of Variation

At the time of each submission, Contractor shall give County specific written notice of each variation that the shop drawings or samples may have from the requirements of the contract documents, and, in addition, shall cause a specific notation to be made on each shop drawing submitted to Engineer for review and acceptance of each such variation.

County's Review

County will review and accept with reasonable promptness shop drawings and samples, but County's review and acceptance will be only for conformance with the design concept of the project and for compliance with the information given in the contract documents and shall not extend to means, methods, techniques, sequences or procedures of construction (except where a specific means, method, technique, sequence or procedure of construction is indicated in or required by the contract documents) or to safety precautions or programs incident thereto. The review and acceptance of a separate item as such will not indicate acceptance of the assembly in which the item functions. Within a reasonable time after receipt of drawings or samples, County will return marked up copies indicating one of the following four actions:

1. If review and checking indicates no exceptions, copies will be returned marked "NO EXCEPTIONS TAKEN" and work may begin immediately on incorporating the material and equipment covered by the submittal into the work.
2. If review and checking indicates limited corrections are required, copies will be returned marked "MAKE CORRECTIONS NOTED" and work may begin immediately on incorporating the material and equipment covered by the submittal into the work.
3. If review and checking indicates insufficient or incorrect data has been submitted, copies will be returned marked "AMEND AND RESUBMIT". No work may begin on incorporating the material and equipment covered by this submittal into the work until the submittal is revised, resubmitted, and returned marked either "NO EXCEPTIONS TAKEN" or "MAKE CORRECTIONS NOTED".

4. If review and checking indicates the material and equipment submittal is unacceptable, copies will be returned marked "REJECTED". No work may begin on incorporating the material and equipment covered by this submittal into the work until a new submittal is made and returned marked either "NO EXCEPTIONS TAKEN" or "MAKE CORRECTIONS NOTED".

Contractor shall direct specific attention in writing to revisions other than the corrections called for by County on previous submittals. The Contractor may authorize material or equipment supplier to deal directly with County with regard to such submittals; however, ultimate responsibility for the accuracy and completeness of the information contained in the submittal shall remain with the Contractor. Normally, a separate transmittal form shall be used for each specific item or class of material or equipment for which a submittal is required. Submittals on various items using a single transmittal form will be permitted only when the items taken together constitute a manufacturer's "package" or are so functionally related that expediency indicates checking or review of the group or "package" as a whole.

Contractor's Responsibility for Variation

County's review of shop drawings or samples shall not relieve Contractor from responsibility for any variation from the requirements of the contract documents unless Contractor has in writing called County's attention to each such variation at the time of submission and County has given written acceptance of each such variation by a specific written notation thereof incorporated in or accompanying the shop drawing or sample review nor will any review by County relieve Contractor from responsibility for errors or omissions in the shop drawings or from responsibility for having complied with the provisions above.

Work Performed Prior to Shop Drawing or Sample Review

Where a shop drawing or sample is required by the specifications, any related work performed prior to County's review of the pertinent submission will be the sole expense and responsibility of Contractor.

ARTICLE XVII: SUBCONTRACTORS, SUPPLIERS AND OTHERS

Objectionable Parties

Contractor shall not employ any subcontractor, supplier or other person or organization, whether initially or as a substitute, against whom County may have reasonable objection. Contractor shall not be required to employ any subcontractor, supplier or other person or organization to furnish or perform any of the work against whom Contractor has reasonable objection. If the contract documents require the identity of certain subcontractors, suppliers or other persons or organizations (including those who are to furnish the principal items of materials and equipment) to be submitted to County in advance for acceptance by County and if Contractor has submitted a list thereof in accordance with the contract documents, County's acceptance (either in writing or by failing to make written objection thereto by the date indicated for acceptance or objection in the bidding documents or the contract documents) of any such subcontractor, supplier or other person or organization so identified may be revoked on the basis of reasonable objection after due investigation, in which case Contractor shall submit an acceptable substitute, the contract price will be increased by the difference in the cost occasioned by such substitution and an appropriate change order will be issued. No acceptance by County of any such subcontractor, supplier, or other person or organization shall constitute a waiver of any right of County to reject defective work. The Contractor may not change any subcontractors listed on its bid without written approval from County after a determination that the requirements of Public Contracts Code Section 4107 have been met.

Responsibility for Subcontractors

Contractor shall be fully responsible to County for all acts and omissions of the subcontractors, suppliers and other persons and organizations performing or furnishing any of the work under a direct or indirect contract with Contractor just as Contractor is responsible for Contractor's own acts and omissions. Nothing in the contract documents shall create any contractual relationship

between County and any such subcontractor, supplier or other person or organization, nor shall it create any obligation on the part of County to pay or to see to the payment of any moneys due any such subcontractor, supplier or other person or organization except as may otherwise be required by laws and regulations. County may furnish to any subcontractor or other person or organization, to the extent practical, evidence of amounts paid the Contractor on account of specific work done.

Division of Work

The divisions and sections of the specifications and the identifications of any drawings shall not control Contractor in dividing the work among subcontractors or suppliers or delineating the work to be performed by any specific trade.

Subcontracts

All work performed for Contractor by a subcontractor will be pursuant to an appropriate agreement between contractor and the subcontractor which specifically binds the subcontractor to the applicable terms and conditions of the contract documents for the benefit of County and contains waiver provisions as required herein. Contractor shall pay each subcontractor a just share of any insurance moneys received by Contractor on account of losses under policies issued pursuant to this Contract.

ARTICLE XVIII: PERFORMANCE OF THE WORK

Supervision

Contractor shall supervise and direct the work competently and efficiently, devoting such attention thereto and applying such skills and expertise as may be necessary to perform the work in accordance with the contract documents. Contractor shall be solely responsible for the means, methods, techniques, sequences, and procedures of construction. Contractor shall be responsible to see that the finished work complies accurately with the contract documents.

Superintendence

Contractor shall keep on the work at all times during its progress a competent resident superintendent, acceptable to County, who shall not be replaced without written notice to County except under extraordinary circumstances. The superintendent will be Contractor's representative at the site and shall have authority to act on behalf of Contractor. All communications given to the superintendent shall be as binding as if given to Contractor. When work is not in progress and during periods when work is suspended, arrangements acceptable to County shall be made for emergencies. If the superintendent is not present, County shall give direction to the next in command and said direction shall be binding.

Personnel

Contractor shall provide competent, suitably qualified personnel to survey and lay out the work and perform construction as required by the contract documents. Contractor shall at all times maintain good discipline and order at the site. Except in connection with the safety or protection of persons or the work or property at the site or adjacent thereto, and except as otherwise indicated in the contract documents, all work at the site shall be performed during regular working hours, and Contractor will not permit overtime work or the performance of work on Saturday, Sunday or any legal holiday without County's written consent given after prior written notice to County.

Order of Work

If a sequence or procedure is specified in the Special Provisions or plans for the project, Contractor shall be required to follow the sequence or procedure specified. The price for compliance with a specified sequence or procedure will be considered as part of the bid price and no extra amounts will be allowed therefor.

Safety and Protection

Contractor shall be solely responsible for initiating, maintaining, and supervising all safety precautions and programs in connection with the work. Contractor shall take all reasonable precautions for the safety of, and shall provide reasonable protection to prevent damage, injury, or loss to:

1. All employees on the work and other persons and organizations who may be affected thereby;
2. All the work and materials and equipment to be incorporated therein, whether in storage on or off the site; and
3. Other property at the site or adjacent thereto, including trees, shrubs, lawns, walks, pavements, roadways, structures, utilities, and underground facilities not designated for removal, relocation, or replacement in the course of construction.

Contractor shall comply with all applicable laws and regulations of any public body having jurisdiction for the safety of persons or property or to protect them from damage, injury, or loss; and shall erect and maintain all necessary safeguards for such safety and protection. Contractor shall notify owners of adjacent property and of underground facilities and utility owners when prosecution of the work may affect them, and shall cooperate with them in the protection, removal, relocation, and replacement of their property. All damage, injury or loss to any property referred to herein caused, directly or indirectly, in whole or in part, by Contractor, any subcontractor, supplier or any other person or organization directly or indirectly employed by any of them to perform or furnish any of the work or anyone for whose acts any of them may be liable, shall be remedied by Contractor. Contractor's duties and responsibilities for the safety and protection of the work shall continue until such time as all the work is completed and County has issued a notice to County and Contractor that the work is acceptable.

The Contractor shall at all times so conduct the work as to insure the least possible obstruction to traffic and inconvenience to the general public and the residents in the vicinity of the work, and to insure the protection of persons and property. No road or street shall be closed to the public except with the permission of County and other governmental authority. Fire hydrants on or adjacent to the work shall be kept accessible to firefighting equipment at all times. Temporary provisions shall be made by the Contractor to insure the use of sidewalks and private and public driveways, and the proper functioning of all gutters, sewer inlets, drainage ditches and culverts, irrigation ditches and natural water courses.

The Contractor shall leave a night emergency telephone number or numbers with the local law enforcement office, so that contact may be made easily at all times in case of trouble or emergencies. The names and telephone numbers of at least two medical doctors practicing in the vicinity and the telephone number of the local ambulance shall be prominently displayed adjacent to all telephones.

Any lighting fixtures shall be installed, mounted, and directed in a manner precluding glare to approaching traffic.

Detours

Where detours are necessary, Contractor shall construct and remove detours as provided in the Special Provisions, or as shown on the plans, or as directed by County. The failure or refusal of Contractor to construct and maintain detours at the required time shall be sufficient cause for closing down the work until remedied. The cost of the detours shall be considered a part of the contract price or as included in other items of work as noted in the Special Provisions and no extra amounts shall be paid therefor.

Safety Representative

Contractor shall designate a responsible representative at the site whose duty shall be the prevention of accidents. This person shall be Contractor's superintendent unless otherwise designated in writing by Contractor to County.

Vehicle Code

Pursuant to the authority contained in Vehicle Code Section 591, County has determined that within such areas as are within the limits of the project and are open to public traffic, the following requirements of the Vehicle Code will apply. The lighting requirements in Section 25803; the brake requirements in Chapter 3, Division 12; the splash apron requirements in Section 27600; and, when operated on completed or existing treated base, surfacing, pavement or structures, except as

otherwise provided in Section 7-1.02, "Weight Limitations," the weight limitation requirements contained in Division 15.

Attention is directed to the statement in said Section 591 that this section shall not relieve Contractor or any person from the duty of exercising due care. The Contractor shall take all necessary precautions for safe operation of its equipment and the protection of the public from injury and damage from such equipment.

Any other requirements set forth in Divisions 11, 12, 13, 14 and 15 of the Vehicle Code which County, pursuant to the authority contained in Vehicle Code Section 591, will require compliance with, will be set forth in the Special Provisions.

Trench Safety

Attention is directed to the provisions of Section 6705 of the Labor Code of the State of California.

Excavation for any trench 5 feet or more in depth shall not begin until the Contractor has submitted to County the Contractor's detailed plan for worker protection from the hazards of caving ground during the excavation of such trench. Such plan shall be submitted at least 5 days before the Contractor intends to begin excavation for the trench and shall show the details of the design of shoring, bracing, sloping, or other provisions to be made for worker protection during such excavation. The plan shall not use shoring, sloping or a protective system less effective than that required by the Construction Safety Orders of the Division of Industrial Safety and if such plan varies from the shoring system standards established by the Construction Safety Orders, the plan shall be prepared and signed by an engineer who is registered as a Civil or Structural Engineer in the State of California.

In addition, the Contractor shall obtain, pay for, and comply with all provisions of the permit required by Section 6500 of the California Occupational Safety and Health Act of 1973.

Notice Prior to Trenching

Where trenching is required, Contractor shall, pursuant to Public Contracts Code Section 7104, promptly, and before the following conditions are disturbed, notify County, in writing of any:

- (1) Material that contractor believes may be material that is hazardous waste, as defined in Section 25117 of the Health and Safety Code, that is required to be removed to a Class I, Class II, or Class III disposal site in accordance with provisions of existing law.
- (2) Subsurface or latent physical conditions at the site differing from those indicated.
- (3) Unknown physical conditions at the site of any unusual nature, different materially from those ordinarily encountered and generally recognized as inherent in work of the character provided for in the contract.

Upon receipt of such notice, County shall, as required by Public Contracts Code Section 7104, promptly investigate the conditions. If County finds the conditions do materially so differ, or do involve hazardous waste, and would require a decrease or increase in Contractor's cost of, or time required for, performance of any part of the work, County shall issue a change order under the procedures described in this Contract. In the event that a dispute arises between County and Contractor as to whether the conditions materially differ, or involve hazardous waste, or cause a decrease or increase in the cost or time required for performance, Contractor will not be excused from the scheduled completion date but shall proceed with all work to be performed. Contractor shall retain its rights to file a claim as set forth herein.

Alcoholic Beverages

Absolutely no alcoholic beverages shall be permitted on the job site.

Emergencies

In emergencies affecting the safety or protection of persons or the work or property at the site or adjacent thereto, Contractor, without special instruction or authorization from County, is obligated to act to prevent threatened damage, injury, or loss. Contractor shall give County prompt written notice as soon as possible thereafter. If County determines that a change in the contract

documents is required because of the action taken in response to an emergency, a change order will be issued to document the consequences of the changes or variations.

Warranty and Guarantee

Unless the plans and/or specifications require a longer period for any warranted item, Contractor warrants all of the work completed under this contract by Contractor for a period of one year from the date of final completion. Said warranty includes the guarantee that all work is completed in accordance with the contract documents and that the work is not defective in any way and is fit for its intended use. Work not conforming to the plans and specifications shall be considered defective. If within the warranty period any work is found to be defective, Contractor shall promptly, without cost to County and in accordance with County's written instruction, either correct such defective work or remove it from the site and replace it with non-defective work. If Contractor does not promptly comply with the terms of such instructions, or in an emergency where delay would cause serious risk of loss or damage, County may have the defective work corrected or removed and replaced, and all direct, indirect, and consequential costs of such removal and replacement (including but not limited to fees and charges of engineers, architects, attorneys and other professionals) will be paid by Contractor. Nothing in this paragraph shall serve as a waiver of the statute of limitations for breach of contract or latent defects.

Environmental and Toxics Warranty

Contractor warrants that no asbestos-containing materials, no PCB-containing fixtures, or equipment or other toxic or hazardous materials or equipment other than what is contained in standard building materials were installed on this project without County's express written consent. Contractor further warrants that no asbestos-containing materials, PCB-containing fixtures, or equipment or other toxic or hazardous materials were discovered during construction of this project which were not disclosed to County in writing.

Contractor also warrants that its operations during the project were not in violation of any applicable federal, state or local environmental law or regulation dealing with hazardous materials or toxic substances, and no notice from any governmental body has been given to Contractor claiming any such violation or calling attention to the need for any work, repairs, construction, or installation or in connection with the project in order to comply with such laws with which Contractor has not complied. If there are any such notices with which Contractor has complied, Contractor shall provide County with copies thereof.

This warranty shall survive completion of the project, and Contractor shall indemnify County for any breach thereof.

Access to Work

County's representatives, testing agencies and governmental agencies with jurisdictional interests will have access to the work at reasonable times for their observation, inspecting and testing. Contractor shall provide proper and safe conditions for such access.

County May Stop the Work

If Contractor fails to conform with the contract documents, if the work is defective, if the work is being carried out in an unsafe manner, or Contractor fails to supply sufficient skilled workers or suitable materials or equipment, or fails to furnish or perform the work in such a way that the completed work will conform to the contract documents, County may order Contractor to stop the work, or any portion thereof, until the cause for such order has been eliminated; however, this right of County to stop the work shall not give rise to any duty on the part of County to exercise this right for the benefit of Contractor or any other party.

Alternative Methods of Construction

Whenever the plans or specifications provide that more than one specified method of construction or more than one specified type of material or construction equipment may be used to perform portions of the work and leave the selection of the method of construction or the type of material or equipment to be used up to the Contractor, it is understood that County does not guarantee that every such method of construction or type of material or equipment can be used successfully

throughout all or any part of any project. It shall be the Contractor's responsibility to select and use the alternative or alternatives which will satisfactorily perform the work under the conditions encountered. In the event some of the alternatives are not feasible or it is necessary to use more than one of the alternatives on any project, full compensation for any additional cost involved shall be considered as included in the contract price paid for the item of work involved and no additional compensation will be allowed therefor.

Correction or Removal of Defective Work

If required by County, Contractor shall promptly, as directed, either correct all defective work, whether or not fabricated, installed, or completed, or, if the work has been rejected by County, remove it from the site and replace it with non-defective work. Contractor shall bear all direct, indirect, and consequential costs of such correction or removal (including but not limited to fees and charges of engineers, architects, attorneys, and other professionals) made thereby.

Acceptance of Defective Work

If, instead of requiring correction or removal and replacement of defective work, County prefers to accept it, County may do so. Contractor shall bear all direct, indirect, and consequential costs attributable to County's evaluation of and determination to accept such defective work (such costs to include but not be limited to fees and charges of engineers, architects, attorneys, and other professionals). If any such acceptance occurs prior to final payment, a change order will be issued incorporating the necessary revisions in the contract documents with respect to the work; and County shall be entitled to an appropriate decrease in the contract price, and, if the parties are unable to agree as to the amount thereof, County may make a claim therefor as provided in this Contract. If the acceptance occurs after such recommendation, an appropriate amount will be paid by Contractor to County. No acceptance of defective work shall occur without an express written acknowledgment by County that work described therein is defective and that County is electing to proceed under this clause. No acceptance of defective work may be inferred from any actions by County staff or its agents.

County May Correct Defective Work

If Contractor fails within a reasonable time after written notice of County to proceed to correct and to correct defective work or to remove and replace rejected work as required by County in accordance with the above, or if Contractor fails to perform the work in accordance with the contract documents, or if Contractor fails to comply with any other provision of the contract documents, County may, after seven days' written notice to Contractor, correct and remedy any such deficiency. In exercising the rights and remedies under this paragraph County shall proceed expeditiously. To the extent necessary to complete corrective and remedial action, County may exclude Contractor from all or part of the site, take possession of all or part of the work, and suspend Contractor's services related thereto, take possession of Contractor's tools, appliances, construction equipment and machinery at the site and incorporate in the work all materials and equipment stored at the site or for which County has paid Contractor but which are stored elsewhere. Contractor shall allow County, County's representatives, agents, and employees such access to the site as may be necessary to enable County to exercise the rights and remedies under this paragraph. All direct, indirect and consequential costs of County in exercising such rights and remedies will be charged against Contractor, and a change order will be issued incorporating the necessary revisions in the contract documents with respect to the work; and County shall be entitled to an appropriate decrease in the contract price, and, if the parties are unable to agree as to the amount thereof, County may make a claim therefor as provided in this Contract. Such direct, indirect, and consequential costs will include but not be limited to fees and charges of engineers, architects, attorneys and other professionals, all court costs and all costs of repair and replacement of work of others destroyed or damaged by correction, removal, or replacement of Contractor's defective work. Contractor shall not be allowed an extension of the contract time because of any delay in performance of the work attributable to the exercise by County of County's rights and remedies hereunder.

Adjusting Progress Schedule

Contractor shall submit to County for acceptance adjustments in the progress schedule to reflect the impact thereon of new developments; these will conform generally to the progress schedule then in effect and additionally will comply with any provisions of the general requirements applicable thereto.

Substitute Method of Construction

If a specific means, method, technique, sequence, or procedure of construction is indicated in or required by the contract documents, Contractor may furnish or utilize a substitute means, method, sequence, technique, or procedure of construction acceptable to County, if Contractor submits sufficient information to allow County to determine that the substitute proposed is equivalent to that indicated or required by the contract documents. The procedure for review by County will be similar to that provided in the paragraph regarding substitution of materials or equipment. No extension of time or extra compensation will be paid to the Contractor by virtue of County's accepting a substitute method of construction.

Suggestions to Contractor

Any plan or method of work suggested by County to the Contractor but not specified or required, if adopted or followed by the Contractor in whole or in part, shall be used at the risk and responsibility of the Contractor; and County shall assume no responsibility therefor and in no way be held liable for any defects in the work which may result from or be caused by use of such plan or method of work. Acceptance by the Contractor of any plan or method of work or change suggested by County shall not relieve the Contractor from any other requirements or provisions of the contract.

Permits

Unless otherwise provided for herein, Contractor shall obtain and pay for all construction permits and licenses necessary or incidental to the work. County shall assist Contractor, when necessary, in obtaining such permits and licenses. Contractor shall pay all governmental charges and inspection fees necessary for the prosecution of the work, which are applicable at the time of opening of bids. County shall pay all charges of utility connections to the work.

Laws and Regulations

Contractor shall give all notices and comply with all laws and regulations applicable to furnishing and performance of the work. Except where otherwise expressly required by applicable laws and regulations, County shall not be responsible for monitoring Contractor's compliance with any laws or regulations. If Contractor observes that the specifications or drawings are at variance with any laws or regulations, Contractor shall give County prompt written notice thereof, and any necessary changes will be authorized by one of the methods indicated herein. If Contractor performs any work knowing or having reason to know that it is contrary to such laws or regulations, and without such notice to County, Contractor shall bear all costs, damages, fines, or penalties, arising therefrom.

Taxes

Contractor shall pay all sales, consumer, use and other similar taxes required to be paid by Contractor in accordance with the laws and regulations of the place of the project which are applicable during the performance of the work.

Use of Premises

Contractor shall confine construction equipment, the storage of materials and equipment and the operations of workers to the project site and land and areas identified in and permitted by the contract documents and other land and areas permitted by laws and regulations, rights-of-way, permits and easements, and shall not unreasonably encumber the premises with construction equipment or other materials or equipment. Contractor shall assume full responsibility for any damage to any such land or area, or to the owner or occupant thereof or of any land or areas contiguous thereto, resulting from the performance of the work. Should any claim be made against County by any such owner or occupant because of the performance of the work, Contractor shall promptly attempt to settle with such other party by agreement or otherwise resolve the claim by arbitration or at law. Contractor shall, to the fullest extent permitted by laws and regulations, indemnify and hold County harmless from and against all claims, damages, losses and expenses

(including, but not limited to, fees of engineers, architects, attorneys and other professionals and court and arbitration costs) arising directly, indirectly or consequentially out of any action, legal or equitable, brought by any such other party against County to the extent based on a claim arising out of Contractor's performance of the work.

Fences which cross, abut, or are on easements shall at all times be maintained by the Contractor in a condition which provides the functional purpose of the fence. Temporary fencing of the construction area will be permitted, and temporary fencing shall provide the same functional purpose as existing fencing. Unless otherwise indicated, all improvements within easements shall be restored to conditions that existed prior to the start of work.

Before final acceptance of the work the Contractor shall obtain a written statement of release from each property owner that granted an easement for the work. Release statement shall indicate the property owner's acceptance of the site conditions as restored by the Contractor. The County may waive said written releases where a property owner refuses to sign same but only upon making a determination that there is no work to be completed with respect to said property.

Site Clean-Up

During the progress of the work, Contractor shall keep the premises free from accumulations of waste materials, rubbish and other debris resulting from the work. At the completion of the work, Contractor shall remove all waste materials, rubbish, and debris from and about the premises as well as all tools, appliances, construction equipment and machinery, and surplus materials, and shall leave the site clean and ready for occupancy by County. Contractor shall restore to original condition all property not designated for alteration by the contract documents.

The Contractor is advised that the final cleanup of the project shall be done with meticulous care and that the County expects all ductwork, cubicles, cabinets, motor control centers, control panels, rooms, and enclosures to be thoroughly vacuum cleaned and dust-free prior to acceptance of the work.

Protection of Structures

Contractor shall not load nor permit any part of any structure to be loaded in any manner that will endanger the structure, nor shall Contractor subject any part of the work or adjacent property to stresses or pressures that will endanger it.

Restoration of Structures

The Contractor shall remove such existing structures or monuments as may be necessary for the performance of the work and, if required, shall rebuild the structures or monuments thus removed in as good a condition as found. Contractor shall also repair all existing structures or monuments which may be damaged as a result of the work under this contract.

All curbs, gutters, driveways, sidewalks, and similar structures that are damaged by the installation of the work shall be reconstructed by the Contractor. Reconstruction shall be of the same kind of material with the same finish and in not less than the same dimensions as the original work. All concrete shall be as set forth in the specifications, or as required by County if not so specified. Repairs shall be made by removing and replacing the entire portions between joints or scores and not merely refinishing any damaged part. All work shall match the appearance of the existing improvements as nearly as possible.

All road and streets where the surface is removed, broken or damaged, or in which the ground has caved or settled due to work under this contract, shall be completely resurfaced and brought to the original grade and crown section unless otherwise indicated. Before resurfacing material is placed, edges of pavements shall be trimmed back far enough to provide clean, solid, vertical faces, and shall be free of any loose material. All cultivated areas, lawns, and other surface improvements which are damaged by actions of the Contractor shall be restored as nearly as possible to their original conditions.

Drainage

Existing drainage facilities shall be maintained throughout the contract time to provide the flow capacities available before commencing work. Drainage conduits shall not be broken, removed, or otherwise interfered with, without permission of the responsible agency.

Where construction requires blocking the flow, flows shall be bypassed as necessary. Stream crossings, blockages, and bypassing shall be accomplished in such a manner as to avoid degradation of downstream water quality. Particular attention shall be given to the avoidance of siltation.

Environmental Control

The Contractor shall not pollute the construction site or any drainage course or its tributary inlets with fuels, oils, bitumens, acids, insecticides, herbicides, or other harmful materials. The Contractor shall comply with all applicable Federal, State, County and municipal laws concerning pollution of waterways. Contractor shall submit a plan for preventing such occurrences if required by County. Special measures shall be taken to prevent chemicals, fuels, oils, greases, bituminous materials, waste washings, herbicides, and insecticides, from spilling and entering public waters.

Where the Contractor is required to connect or otherwise work around existing lines carrying sewage or process wastes, Contractor shall perform the work to prevent the spill of sewage and insure the delivery of sewage to the treatment plants. Where the Contractor chooses to provide temporary pumping of sewage, Contractor shall first have the pumping facilities approved by County and shall provide 100 percent standby equipment on 24-hour basis.

The Contractor shall provide the means for preventing or lessening all dust nuisances and damages. Such means shall consist of applying water, dust palliative, or both all in accordance with local ordinances and regulations or as directed by County.

Record Documents

Contractor shall maintain in a safe place at the site one record copy of all drawings, plans, specifications, addenda, change orders, field orders and written interpretations and clarifications in good order and annotated to show all changes made during construction. These record documents together with all approved samples and a counterpart of all accepted shop drawings will be available to County for reference. Upon completion of the work, these record documents, samples, and shop drawings will be delivered to County.

As-Built Drawings

The Contractor shall also maintain a neatly marked set of record drawings showing the final locations and layout of all mechanical, electrical, and instrument equipment, piping and conduit, structures, and other facilities. Drawings shall be kept current weekly, with all field instructions and change orders; mechanical, electrical, and instrumentation equipment accommodations; and construction adjustment. Drawings shall be subject to the inspection of the County at all times and progress payments may be withheld if drawings are not current. At the final inspection the Contractor shall submit to County all as-built drawings. Drawings shall be stamped "AS-BUILT", dated, and signed by the Contractor. The work will not be formally accepted until as-built drawings are accepted by County.

Continuing the Work

Contractor shall carry on the work and adhere to the progress schedule during all disputes or disagreements with County. No work shall be delayed or postponed pending resolution of any disputes or disagreements, except as permitted specifically herein or as Contractor and County may otherwise agree in writing.

Indemnification

To the fullest extent permitted by laws and regulations, Contractor shall indemnify, defend and hold harmless County and its consultants, agents and employees from and against all claims, damages, losses and expenses, direct, indirect or consequential (including but not limited to fees and charges of engineers, architects, attorneys and other professionals and court and arbitration costs) arising out of or resulting from the performance of the work, provided that any such claim, damage, loss or

expenses (a) is attributable to bodily injury, sickness, disease or death, or to injury to or destruction of tangible property (including the work itself) including the loss of use resulting therefrom and (b) is caused in whole or in part by any negligent act or omission of Contractor, any subcontractor, any person or organization directly or indirectly employed by any of them to perform or furnish any of the work or anyone for whose acts any of them may be liable. The Contractor's indemnification obligation shall apply whether or not the act giving rise to such claims, damages, losses, and expenses is caused in part by a party indemnified hereunder or arises by or is imposed by law and regulations regardless of the negligence of any such party.

Statutory Limitations

In any and all claims against County or any of its consultants, agents or employees by any employee of Contractor, any subcontractor, any person or organization directly or indirectly employed by any of them to perform or furnish any of the work or anyone for whose acts any of them may be liable, the indemnification obligation above shall not be limited in any way by any limitation on the amount or type of damages, compensation or benefits payable by or for Contractor or any such subcontractor or other person or organization under workers' compensation acts, disability benefit acts or other employee benefit acts.

Related Work at Site

County may perform other work related to the project at the site by County's own forces, have other work performed by utility companies or let other direct contracts therefor which shall contain conditions similar to these. If the fact that such other work is to be performed was not noted in the contract documents, written notice thereof will be given to Contractor prior to starting any such other work; and, if Contractor believes that such performance will involve additional expense to Contractor or requires additional time and the parties are unable to agree as to the extent thereof, Contractor may make a claim therefor as provided for herein. Any difference or conflict arising between the Contractor and any other Contractor employed by County, or between the Contractor and the workers of County with regard to their work, shall be submitted to County and the Contractor shall abide by County's decision in the matter. If the work of the Contractor is delayed because of any facts or omissions of any other Contractor or of County, the Contractor shall on that account have no claim against County other than for an extension of time.

Access to Site

Contractor shall afford each utility company or district and other contractor who is a party to such a direct contract (or County, if County is performing the additional work with County's employees) proper and safe access to the site and a reasonable opportunity for the introduction and storage of materials and equipment and the execution of such work, and shall properly connect and coordinate the work with theirs. Contractor shall do all cutting, fitting, and patching of the work that may be required to make its several parts come together properly and integrate with such other work. Contractor shall not endanger any work of others by cutting, excavating, or otherwise altering their work and will only cut or alter their work with the written consent of County and the others whose work will be affected. The duties and responsibilities of Contractor under this paragraph are for the benefit of such utility companies or districts and other contractors to the extent that there are comparable provisions for the benefit of Contractor in said direct contracts between County and such utility companies or districts and other contractors.

Acceptance of Work by Others

If any part of Contractor's work depends for proper execution or results upon the work of any such other contractor or utility company or district (or County), Contractor shall inspect and promptly report to County in writing any delays, defects or deficiencies in such work that render it unavailable or unsafe for such proper execution and results. Contractor's failure so to report will constitute an acceptance of the other work as fit and proper for integration with Contractor's work except for latent or nonapparent defects and deficiencies in the other work.

ARTICLE XIX: TESTS AND INSPECTIONS

Tests and Inspections Required by Laws or Regulations

If laws or regulations of any public body having jurisdiction require any work (or part thereof) to specifically be inspected, tested, or approved, Contractor shall assume full responsibility therefor, pay all costs in connection therewith and furnish County the required certificates of inspection, testing, approval, or compliance. Contractor shall also be responsible for and shall pay all costs in connection with any inspection or testing required in connection with County's acceptance of a supplier of materials or equipment proposed to be incorporated in the work, or of materials or equipment submitted for approval prior to Contractor's purchase thereof for incorporation in the work. The cost of all inspections, tests, and approvals in addition to the above which are required by the contract documents shall be paid by County (unless otherwise specified). Contractor must utilize materials and equipment which are available for inspection at the plant or at the point of distribution in California in the case of foreign materials or equipment.

Other Inspections and Tests

All inspections, tests, or acceptances other than those required by laws and regulations of any public body having jurisdiction shall be performed by organizations acceptable to County.

General Requirements

All materials, equipment, installation, and workmanship included in this contract, if so, required by County, shall be tested, and inspected to prove compliance with the contract requirements. Installed leakage tests and other piping tests shall be as specified in the technical provisions of these specifications.

No tests specified herein shall be applied until the item to be tested has been inspected and approval given for the application of such test. Contractor shall give County timely notice of readiness of the work for all required inspections, tests, or approvals.

Tests and inspections shall include:

1. The delivery acceptance test and inspections.
2. The installed tests and inspections of items as installed.

Tests and inspections, unless otherwise specified or accepted, shall be in accordance with the recognized standards of the industry.

The form of evidence of satisfactory fulfillment of delivery acceptance test and of installed test and inspection requirements shall be, at the discretion of County, either by tests and inspections carried out in County's presence or by certificates or reports of tests and inspections carried out by approved persons or organizations. The Contractor shall provide and use forms which include all test information and are acceptable in content to County.

Certificates of Compliance

A Certificate of Compliance shall be furnished prior to the use of any materials for which the specifications or the Special Provisions require that such a certificate be furnished. In addition, when so authorized in the specifications or in the Special Provisions, the County may permit the use of certain materials or assemblies prior to sampling and testing if accompanied by a Certificate of Compliance. The certificate shall be signed by the manufacturer of the material or the manufacturer of assembled materials and shall state that the materials involved comply in all respects with the requirements of the specifications. A Certificate of Compliance shall be furnished with each lot of material delivered to the work and the lot so certified shall be clearly identified in the certificate.

All materials used on the basis of a Certificate of Compliance may be sampled and tested at any time. The fact that material is used on the basis of a Certificate of Compliance shall not relieve the Contractor of responsibility for incorporating material in the work which conforms to the requirements of the plans and specifications and any such material not conforming to such requirements will be subject to rejection whether in place or not.

County reserves the right to refuse to permit the use of material on the basis of a Certificate of Compliance.

The form of the Certificate of Compliance and its disposition shall be as directed by County.

Delivery Acceptance Tests and Inspection

The delivery acceptance tests, and inspection shall be at the Contractor's expense for any materials or equipment specified herein and shall include the following:

1. Test of items during the process of manufacture and/or on completion of manufacture, comprising material tests, hydraulic pressure tests, electric tests, performance and operating tests and inspections in accordance with the relevant standards of the industry and more particularly as detailed in individual clauses of these specifications to satisfy County that the items tested and inspected comply with the requirements of this contract. Tests required, other than those specified, will be in accordance with the contract specifications.
2. Inspection of all items delivered at the site in order that County may be satisfied that such items are of the specified quality and workmanship and are in good order and condition at the time of delivery.

Installed Tests and Inspection

All equipment shall be tested by the Contractor to the satisfaction of County before any facility is put into operation. Tests shall be as specified herein and shall be made to determine whether the equipment has been properly assembled, aligned, adjusted, and connected. Any changes, adjustments or replacements required to make the equipment operate as specified shall be carried out by the Contractor as part of the work.

At least 30 days before the time allowed in the construction schedule for commencing testing and start up procedures, the Contractor shall submit to County, details of the procedures Contractor proposes to adopt for testing and startup of all mechanical and electrical equipment to be operated singly and together, excepting when such procedures have been covered in the specifications. Such tests shall be conducted using potable water where water is required for such testing. The water required for such tests shall be provided by the Contractor.

During the testing of equipment, the Contractor shall make available experienced factory trained representatives of the manufacturers of all the various pieces of equipment, or other qualified persons who shall instruct County's personnel in the operation and care thereof. Instruction shall include step-by-step troubleshooting procedures with all necessary test equipment. All manufacturer's instructions shall be provided in writing.

If, under test, any portion of the work shall fail to fulfill the contract requirements and is altered, renewed or replaced, tests on that portion when so altered, removed or replace, together with all other portions of the work as are affected thereby, shall, if so required by County, be repeated within reasonable time and in accordance with the specified conditions, and the Contractor shall pay to County all reasonable expenses incurred by County as a result of the carrying out of such tests.

Where, in the case of an otherwise satisfactory installed test, any doubt, dispute, or difference should arise between County and the Contractor regarding the test results or methods or equipment using in the carrying out by the Contractor of such test, then County may order the test to be repeated. If the repeat test, using such modified methods or equipment as County may require, substantially confirms the previous test then costs in connection with the repeat test will be paid by County, otherwise the costs shall be borne by the Contractor. Where the results of any installed test fail to comply with the contract requirements for such test then such repeat tests as may be necessary to achieve the contract requirements shall be made by the Contractor at Contractor's own expense.

Quality Control

County will perform testing for the following as the County deems necessary:

1. Soils compaction control
2. Cast-in-place concrete control
3. Aggregate base rock
4. Portland Cement concrete
5. Asphalt concrete
6. Other materials and work incorporated in project

The Contractor shall pay for testing of those samples which fail to meet acceptable standards.

The Contractor shall provide services of a qualified testing laboratory to perform testing for all other work including but not limited to:

1. Concrete mix design
2. Asphalt concrete mix design

The testing laboratory selected by the Contractor is subject to County's approval. The laboratory shall cooperate with Contractor and County and provide qualified personnel promptly on notice, perform specified inspections, sampling and testing of materials as needed to comply with specified standards, and ascertain compliance with requirements of contract documents.

Work Requiring Testing

If any work (including the work of others) that is required by the Contract Documents to be inspected, tested, or accepted is covered without written concurrence of County, it must, if requested by County, be uncovered for observation. Such uncovering shall be at Contractor's expense unless Contractor has given County timely notice of Contractor's intention to cover the same and County has not acted with reasonable promptness in response to such notice.

Contractor's Obligation

Neither observations by County nor inspections, tests or approvals by others shall relieve Contractor from Contractor's obligations to perform the work in accordance with the contract documents.

Uncovering Work Covered Contrary to County's Request

If any work is covered contrary to the written instructions of County or Code or contract requirements, it must, if requested by County, be uncovered for County's observation, and replaced at Contractor's expense.

Uncovering Work for Inspection or Testing

In addition to the provisions above regarding work requiring testing, if County considers it necessary or advisable that covered work be observed by County or inspected or tested by others, Contractor, at County's request, shall uncover, expose, or otherwise make available for observation, inspection or testing as County may require, that portion of the work in question, furnishing all necessary labor, material, and equipment. If it is found that such work is defective, Contractor shall bear all direct, indirect and consequential costs of such uncovering, exposure, observation, inspection and testing and of satisfactory reconstruction (including but not limited to fees and charges of engineers, architects, attorneys and other professionals), and County shall be entitled to an appropriate decrease in the contract price, and, if the parties are unable to agree as to the amount thereof, may make a claim therefor as provided in this contract. If, however, such work is not found to be defective, Contractor shall be allowed an increase in the contract price or an extension of the contract time, or both, directly attributable to such uncovering, exposure, observation, inspection, testing and reconstruction; and, if the parties are unable to agree as to the amount or extent thereof, Contractor may make a claim therefor as provided for in this contract.

ARTICLE XX: SUSPENSION OF WORK AND TERMINATION

County May Suspend Work

County may, at any time and without cause, suspend the work or any portion thereof for a period of not more than ninety days by notice in writing to Contractor. As soon as possible, County will fix the date on which work will be resumed. Contractor shall resume the work on the date so fixed. If Contractor believes that such suspension justifies an increase in the contract price or an extension of the contract time and County and Contractor are unable to agree to the amount or extent thereof, Contractor may make a claim therefor as provided herein.

County May Terminate

Except as limited by law or regulation, County may terminate upon the occurrence of any one or more of the following events:

1. If Contractor commences a voluntary case under any chapter of the Bankruptcy Code (Title 11, United States Code), as now or hereafter in effect, or if Contractor takes any equivalent or similar action by filing a petition or otherwise under any other federal or state law in effect at such time relating to the bankruptcy or insolvency;
2. If petition is filed against Contractor under any chapter of the Bankruptcy Code as now or hereafter in effect at the time of filing, or if a petition is filed seeking any such equivalent or similar relief against Contractor under any other federal or state law in effect at the time relating to bankruptcy or insolvency;
3. If Contractor makes a general assignment for the benefit of creditors;
4. If a trustee, receiver, custodian, or agent of Contractor is appointed under applicable law or under contract, whose appointment or authority to take charge of property of Contractor is for the purpose of enforcing a lien against such property or for the purpose of general administration of such property for the benefit of Contractor's creditors;
5. If Contractor admits in writing an inability to pay its debts generally as they become due;
6. If Contractor persistently fails to perform the work in accordance with the contract documents (including, but not limited to, failure to supply sufficient skilled workers or suitable materials or equipment or failure to adhere to the progress schedule established herein as revised from time to time or fails to make prompt payment to subcontractors or for materials or labor or persistently disregards laws, ordinances, or instructions of the County);
7. If Contractor disregards laws or regulations of any public body having jurisdiction;
8. If Contractor disregards the authority of County or its agents; or
9. If Contractor otherwise violates in any substantial way any provisions of the contract documents;

County may, after giving Contractor (and the surety, if there be one) seven days' written notice and to the extent permitted by laws and regulations, terminate the services of Contractor, exclude Contractor from the site and take possession of the work and of all Contractor's tools, appliances, construction equipment and machinery at the site and use the same to the full extent they could be used by Contractor (without liability to Contractor for trespass or conversion), incorporate in the work all materials and equipment stored at the site or for which County has paid Contractor but which are stored elsewhere, and finish the work as County may deem expedient. In such case Contractor shall not be entitled to receive any further payment until the work is finished. If the unpaid balance of the contract price exceeds the direct, indirect, and consequential costs of completing the work (including but not limited to fees and charges of engineers, architects, attorneys and other professionals and court costs) such excess will be paid to Contractor. If such costs exceed such unpaid balance, Contractor shall pay the difference to County. Such costs incurred by County will be approved as to reasonableness by County and incorporated in a change order, but when exercising any rights or remedies under this paragraph County shall not be required to obtain the lowest price for the work performed. Where Contractor's services have been so terminated by County, the termination will not affect any rights or remedies of County against Contractor then existing or which may thereafter accrue. Any retention or payment of moneys due Contractor by County will not release Contractor from liability.

County May Abandon

Upon written notice to Contractor County may, without cause and without prejudice to any other right or remedy, elect to abandon the work and terminate the agreement. Contractor shall stop work as specified in said notice, terminate all subcontracts, deliver all materials already paid for and secure the site. In such case, Contractor shall be paid for all work executed and any actual expense sustained. No lost profit for work not yet undertaken shall be due to Contractor.

Contractor May Stop Work or Terminate

If, through no act or fault of Contractor, the work is suspended for a period of more than ninety days by County or under an order of court or other public authority, or County fails to act on any application for payment within thirty days after it is submitted, or County fails for thirty days to pay Contractor any sum finally determined to be due, then Contractor may, upon seven days' written notice to County, terminate the agreement and recover from County payment for all work executed and any expense sustained. In addition, and in lieu of terminating the agreement, if County has failed to act on an application for payment or County has failed to make any payment as aforesaid, Contractor may upon seven days' written notice to County stop the work until payment of all amounts then due. The provisions of this paragraph shall not relieve Contractor of the obligations to carry on the work in accordance with the progress schedule and without delay during disputes and disagreements with County.

ARTICLE XXI COUNTY'S AGENT'S STATUS DURING CONSTRUCTION

County's Representative

County may appoint representatives during the construction period. The duties and responsibilities and the limitations of authority of such agents during construction are set forth herein and shall not be extended without written consent of County.

Agent's Authority

County may delegate authority to an employee or agent, including an engineer or an architect, to determine the amount, quality, acceptability and fitness of the several kinds of work, material and equipment which are to be paid for under the contract; to decide for the County all questions relative to the true construction, meaning and intent of the contract documents; to decide all questions relative to the classification and measurements of quantities and materials and the fulfillment of this contract, and to reject or condemn all work or material which does not conform to the terms of this contract. The representative's decision in all matters is the decision of County and shall be final and binding on Contractor.

Replacement of Representative

County reserves the right to terminate the employment of the representative at any time.

Visits to Site

Where a representative represents County, said representative will make visits to the site at intervals appropriate to the various stages of construction to observe the progress and quality of the executed work and to determine, in general, if the work is proceeding in accordance with the contract documents. However, Contractor must supervise the work and cannot rely on said representative or County as they will not be required to make exhaustive or continuous on-site inspections to check the quality or quantity of the work. The representative's efforts will be directed toward providing for County a greater degree of confidence that the completed work will conform to the contract documents. On the basis of such visits and on-site observations, the representative will keep County informed of the progress and adequacy of the work.

Observation of Work

If County and the representative agree, the representative will observe the performance of the work. The duties, responsibilities, and limitations of authority of the representative in observing the work will be as provided herein. If County designates another agent to represent County at the site who is not the representative's agent or employee, the duties, responsibilities, and limitations of authority of such other person will be as provided in supplementary conditions.

Clarifications and Interpretations

The representative may be appointed to issue (with reasonable promptness) such written clarifications or interpretations of the requirements of the contract documents (in the form of drawings or otherwise) as the representative may determine necessary, which shall be consistent with or reasonably inferable from the overall intent of the contract documents. If Contractor believes that a written clarification or interpretation justifies an increase in the contract price or an extension of the contract time and the parties are unable to agree to the amount or extent thereof, Contractor may make a claim therefor as provided in the contract. Said claim shall be made to County unless a representative has been selected to provide such clarifications or interpretations.

Authorized Variations in Work

If a representative is appointed, such representative may authorize minor variations in the work from the requirements of the contract documents which do not involve an adjustment in the contract price or the contract time and are consistent with the overall intent of the contract documents. These may be accomplished by a field order and will be binding on County, and also on Contractor who shall perform the work involved promptly. If Contractor believes that a field order justifies an increase in the contract price or an extension of the contract time and County and Contractor are unable to agree as to the amount or extent thereof, Contractor may make a claim therefor as provided in this Contract.

Rejecting Defective Work

If a representative is appointed, such representative will have authority to disapprove or reject work which the representative believes to be defective, and will also have authority to require special inspection or testing of the work whether or not the work is fabricated, installed, or completed. Any decision made by said representative in disapproving or rejecting work shall be binding on Contractor.

Determinations for Unit Prices

If a representative is appointed, such representative will determine the actual quantities and classifications of unit price work performed by Contractor. The representative will review with the Contractor the representative's preliminary determinations on such matters before rendering a written decision thereon (by recommendation of an application for payment or otherwise). The representative's written decisions thereon will be final and binding upon Contractor.

Claims and Disputes

For purposes of this paragraph, "claim" shall be defined as set forth in Public Contracts Code Section 20104(b)(2). Claims shall be presented in writing and include the documents necessary to substantiate the claim. Claims must be filed with the designated County representative no later than thirty (30) days after the occurrence of the event giving rise thereto or denial of the change order, whichever occurs last. The form of said claims shall be the same as is required by Government Code Sections 910 and 910.2.

If the claim is under \$50,000, County shall respond in writing to Contractor within 45 days of receipt of Contractor's claim or may request, in writing, within 30 days of receipt of the claim, any additional documentation supporting the claim or relating to defenses or claims the County may have against the Contractor. If additional information is thereafter required, it shall be requested and provided pursuant to Public Contract Code Section 20104.2, upon mutual agreement of the County and Contractor. The County's written response to the claim, as further documented, shall be submitted to Contractor within 15 days after receipt of the further documentation or within a period of time no greater than that taken by Contractor in producing the additional information, whichever is greater.

For claims over \$50,000 and less than or equal to \$375,000, County shall respond in writing to all written claims within 60 days of receipt of the claim, or may request, in writing within 30 days of receipt of the claim, any additional documentation supporting the claim or relating to defenses or claims the County may have against Contractor. If additional information is thereafter required, it shall be requested and provided pursuant to Public Contract Code Section 20104.2, upon mutual agreement of County and Contractor. The County's written response to the claim, as further documented, shall be submitted to Contractor within 30 days after receipt of the further

documentation, or within a period of time no greater than that taken by Contractor in producing the additional information or requested documentation, whichever is greater.

If Contractor disputes County's written response, or County fails to respond within the time prescribed above, Contractor may so notify County, in writing, either within 15 days of receipt of County's response or within 15 days of County's failure to respond within the time prescribed, respectively, and demand an informal conference to meet and confer with such County representatives as the County Administrator or the Board of Supervisors directs for settlement of the issues in dispute. Upon such demand, County shall schedule a meet and confer conference within 30 days for settlement of the dispute.

Following the meet and confer conference, if the claim or any portion remains in dispute, Contractor may file a claim with the Board of Supervisors pursuant to Chapter 1 (commencing with Section 900) and Chapter 2 (commencing with Section 910) of Part 3 of Division 3.6 of Title 1 of the Government Code. Pursuant to authority granted by Government Code Section 930.2, all claims filed with the Board of Supervisors pursuant to the Government Code shall be filed within 90 days of the denial of the original claim by the County representative. The running of the period of time within which a claim under the Government Code must be filed shall be tolled by any period of time utilized by the meet and confer conference. Any lawsuit which Contractor intends to bring with respect to any claim filed pursuant to the Government Code which claim has been denied by County must be commenced not later than six months after the recording of the notice of completion or not later than six months after the date final payment is deposited in the mail or personally delivered, whichever date comes first. If a civil action is filed, the mediation provisions set forth in Public Contract Code Section 20104.4 shall apply unless waived by mutual stipulation of County and Contractor or unless County elects to resolve the dispute pursuant to Public Contract Code Section 10240 et seq.

Effective January 1, 2017, Public Contract Code §9204, as enacted by AB 626, establishes a claim resolution process required for public works projects. In the event of any conflict between the provisions of Article XXI and Public Contract Code §9204, the provisions of the Public Contract Code shall prevail. The entire section can be found at the following link:

https://leginfo.legislature.ca.gov/faces/codes_displayText.xhtml?lawCode=PCC&division=2.&title=&part=1.&chapter=9.&article

For every claim that Contractor makes, it shall provide the following documentation upon request of County as a condition precedent to consideration of the claim: Contractor's bidding calculations forms, cost estimates, time sheets, trend reports, job cost analysis records, labor records, as-built documents, any other records used by Contractor in arriving at its bid price, and any other documents or records kept by Contractor during the course of construction. In the event that claims are made, Contractor agrees that County shall have the right to conduct a complete audit of the books and records of Contractor relating to this project and any books and records relating to overhead, profit or general office expenses charged to this project.

Representative's Decision

Where a representative is appointed, the rendering of a decision by the representative with respect to any such claim, dispute, or other matter (except any which have been waived by the making or acceptance of final payment) will be a condition precedent to any exercise by County or Contractor of such rights or remedies as either may otherwise have under the contract documents or by laws or regulations in respect of any such claim, dispute or other matter.

Limitations on Representative's Responsibilities

Neither the County's representative's authority to act nor any decision made by the representative in good faith either to exercise or not exercise such authority shall give rise to any duty or responsibility of the representative or County to Contractor, any subcontractor, any supplier, or any other person or organization performing any of the work, or to any surety for any of them.

Construction Methods and Safety

Notwithstanding any references to laws and regulations, rules, codes, or standards in the contract documents, the representative and County will not be responsible for Contractor's means, methods, techniques, sequences or procedures of construction, or the safety precautions and programs incident thereto, and the representative and County will not be responsible for Contractor's failure to perform or furnish the work in accordance with the contract documents.

Acts and Omissions of Contractor

Neither the County nor its representatives will be responsible for the acts or omissions of Contractor or of any subcontractor, any supplier, or any other person or organization performing or furnishing any of the work.

ARTICLE XXII: PARTIAL COMPLETION

Partial Completion (Completion of a Portion of the Work)

Use by County of any finished part of the work, which has specifically been identified in the contract documents, or which County and Contractor agree constitutes a separately functioning process or facility that can be used by County without significant interference with Contractor's performance of the remainder of the work, may be accomplished prior to completion of all the work subject to the following:

1. County at any time may request Contractor in writing to permit County to use any such part of the work which County believes to be ready for its intended use and substantially complete. If Contractor agrees, Contractor will certify to County that said part of the work is substantially complete and request County to issue a certificate of substantial completion for that part of the work. Contractor at any time may notify County in writing that Contractor considers any such part of the work ready for its intended use and substantially complete and request County to issue a certificate of substantial completion for that part of the work. Within a reasonable time after either such request, County and Contractor shall make an inspection of that part of the work to determine its status of completion. If County does not consider that part of the work to be substantially complete, County will notify Contractor in writing giving the reasons therefor. If County considers that part of the work to be substantially complete, County will deliver to Contractor a written recommendation as to the division of responsibilities pending final payment between County and Contractor for the entire work with respect to security, operation, safety, maintenance, heat, utilities, insurance, and warranties. Unless Contractor disagrees in writing and so informs County promptly, County's aforesaid recommendation will be binding on Contractor until final payment for the entire work.
2. County may at any time request Contractor in writing to permit County to take over operation of any such part of the work although it is not substantially complete. A copy of such request will be sent to Contractor and within a reasonable time thereafter County and Contractor shall make an inspection of that part of the work to determine its status of completion and will prepare a list of the items remaining to be completed or corrected thereon before final payment. If Contractor does not object in writing to County that such part of the work is not ready for separate operation by County, County will finalize the list of items to be completed or corrected and will deliver such list to Contractor together with a written recommendation as to the division of responsibilities pending final payment between County and Contractor with respect to security, operation, safety, maintenance, utilities, insurance, warranties and guarantees for that part of the work which will become binding upon County and Contractor at the time when County takes over such operation (unless they shall have otherwise agreed in writing). During such operation and prior to substantial completion of such part of the work, County shall allow Contractor reasonable access to complete or correct items on said list and to complete other related work.
3. No occupancy or separate operation of part of the work will be accomplished prior to the insurers who are then providing the property insurance having acknowledged notice thereof

and in writing effecting the changes in coverage necessitated thereby. The insurers providing the property insurance shall consent by endorsement on the policies, but the property insurance shall not be canceled or lapse on account of any such partial use or occupancy. Each party shall be responsible for notifying its own insurer.

ARTICLE XXIII: ARBITRATION

Arbitration

Where the total of all claims filed by Contractor are under \$375,000, County shall have the option of electing arbitration pursuant to Public Contract Code Sections 10240, et seq. If County does so elect, the mediation provisions of Public Contract Code Section 20104.4 shall not apply pursuant to Public Contract Code Section 20104(a)(2). If County does not elect such arbitration pursuant to Public Contract Code Sections 10240 et seq., the provisions of Public Contract Code Section 20104.4 shall apply.

Where the total of all claims filed by Contractor are above \$375,000, the arbitration provisions of this contract are voluntary. Neither County nor Contractor shall be required to enter into mediation or arbitration for amounts above \$375,000. Written consent of both parties to mediate or arbitrate such claims shall be a prerequisite to such mediation or arbitration. If the parties agree to arbitrate claims above \$375,000, the provisions of Public Contract Code Sections 10240, et seq. shall be utilized.

Time to Request Arbitration

No request for arbitration of any claim, dispute or other matter that is required to be referred to County initially for decision will be made until the earlier of (a) the date on which County has rendered a decision or (b) the tenth day after Contractor has presented its evidence to County if a written decision has not been rendered by County before that date. Unless otherwise required by law, no request for arbitration of any such claim, dispute or other matter will be made later than thirty days after the date on which County has rendered a written decision. Notice of the request for arbitration will be in writing to the other party.

ARTICLE XXIV: LABOR AND EMPLOYMENT

Worker's Compensation Certification

By my signature hereunder, as Contractor, I certify that I am aware of the provisions of Section 3700 of the Labor Code which requires every employer to be insured against liability for Worker's Compensation or to undertake self-insurance in accordance with the provisions of that Code, and I will comply with such provisions before commencing the performance of the work of this contract.

Prevailing Wage Rates

In accordance with the provisions of Section 1770 and 1773 of the Labor Code, the County of Nevada has determined that prevailing wage rates are applicable to the work to be done. The Contractor shall post a copy of the wage rates on the job site.

The general prevailing wage rates determined by the Director of Industrial Relations, for the county or counties in which the work is to be done, are available from the California Department of Industrial Relations' Internet website at <http://www.dir.ca.gov> . These wage rates are not included in the Bid Form and contract for the project. Changes, if any, to the general prevailing wage rates will be available at the same location.

Pursuant to California Labor Code Section 1775, Contractor shall forfeit Fifty Dollars (\$50.00) for each calendar day, or portion thereof, for each worker paid less than the prevailing rates for such work or craft, and said amounts shall be distributed pursuant to the requirements of said Section 1775. Any employee whose type of work is not covered by any of the classified wage rates shall be paid not less than the rate of wage listed for the classification which most nearly corresponds to the type of work to be performed.

Collective Bargaining Agreements

Pursuant to California Labor Code Section 1773.8, Contractor shall pay travel and subsistence payments to all workers needed to execute the work as such travel and subsistence payments are defined in the applicable collective bargaining agreements filed in accordance with Section 1773.8 of the Labor Code.

Payroll Records

Contractor shall be responsible for keeping accurate payroll records as required by California Labor Code Section 1776. Contractor is aware that a penalty of twenty-five dollars (\$25.00) per day or portion thereof for each worker may be assessed for noncompliance with said section. Contractor shall forward to County a certified copy of each payroll record within ten days after close of each payroll period. Such certification shall include a statement that payroll is correct and complete and complies with prevailing wage requirements.

If by the 15th of the month, the Contractor has not submitted satisfactory payrolls for all work performed during the monthly period ending on or before the 1st of that month, County will retain an amount equal to 10 percent of the estimated value of the work performed during the month from the next monthly estimate, except that such retention shall not exceed \$10,000. Retentions for failure to submit satisfactory payrolls shall be additional to all other retentions provided for in the contract. The retention for failure to submit payrolls for any monthly period will be released for payment on the monthly estimate for partial payments next following the date that all the satisfactory payrolls for which the retention was made are submitted.

The Contractor and each subcontractor shall preserve their payroll records for a period of three years from the date of completion of the contract.

Limitations on Hours Worked

Eight hours constitutes a day's work and workers shall be limited to working 8 hours during any one calendar day and 40 hours during any one calendar week. Contractor and all subcontractors shall keep an accurate record of hours worked by each worker for each calendar day and each calendar week which record shall be available for inspection during business hours. Contractor shall, pursuant to California Labor Code Section 1813, forfeit twenty-five dollars (\$25) for each day for each worker where such worker is required or permitted to work more than 8 hours in any one day and 40 hours in any one week in violation of the provisions of the Labor Code. No overtime shall be authorized unless prior written approval of County is obtained permitting such overtime. If such overtime work is authorized by County, Contractor shall compensate each worker required to work overtime at the rate of one and one-half (1-1/2) times the basic rate of pay. All costs for overtime inspection, except those occurring as a result of overtime and shift work established as a regular procedure, shall be paid by the Contractor. Overtime inspection shall include inspection required during holidays, Saturdays, Sundays, and any weekday between the hours of 5:00 p.m. and 7:00 a.m. Such costs will include but will not necessarily be limited to engineering, inspection, general supervision, and other overhead expenses which are directly chargeable to the overtime work. All such charges shall be deducted by County from payments due the Contractor.

Equal Employment Opportunity and Nondiscrimination

During the performance of this contract, the contractor agrees to abide by all provisions of Section 1735 of the California Labor Code, as amended, regarding nondiscrimination practices.

Employment of Apprentice Labor

Reference is hereby made to Section 1777.5 of the Labor Code of the State of California, which regulations shall govern the employment of apprentices on the work.

Preference for Resident Labor

In the employment of labor for doing the work, the Contractor shall give preference to qualified persons residing within the general area of the work.

Incompetent Workers

If at any time any worker employed by Contractor or any of the subcontractors shall be declared by County to be incompetent or unfaithful in executing the work, the Contractor, on receiving written notice, shall forthwith initiate appropriate action to dismiss such person.

Labor Class Substitutions

If Contractor substitutes a labor classification or provides a new classification which results in a reduction in the contract price, County's execution of a change order evidencing said reduction in price shall in no way be construed, either express or implied, as consent to the use of said labor classification in the performance of any work on the project.

ARTICLE XXV: ASSIGNMENT

No assignment by a party hereto of any rights under or interests in the contract documents will be binding on another party hereto without the written consent of the party sought to be bound; and specifically but without limitation, moneys that may become due and moneys that are due may not be assigned without such consent (except to the extent that the effect of this restriction may be limited by law), and unless specifically stated to the contrary in any written consent to an assignment no assignment will release or discharge the assignor from any duty or responsibility under the contract documents.

ARTICLE XXVI: CONFLICT OF INTEREST RESTRICTIONS

No official of County who is authorized in such capacity and on behalf of County to negotiate, make, accept, or approve, or to take part in negotiating, making, accepting, or approving any architectural, engineering, inspecting, construction or material supply contract or any subcontract in connection with the construction of the project, shall become directly or indirectly interested personally in this contract or in any part thereof. No officer, employee, architect, attorney, engineer, or inspector of or for County who is authorized in such capacity and on behalf of County who is in any legislative, executive, supervisory, or other similar function in connection with the construction of the project, shall become directly or indirectly interested personally in this contract or in any part thereof, any material supply contract, subcontract, insurance contract, or any other contract pertaining to the project.

ARTICLE XXVII: WAIVER OF RIGHTS

No action or lack of action on the part of County at any time to exercise any right or remedy conferred upon it under this contract shall be deemed to be a waiver on the part of County of any of County's rights or remedies.

ARTICLE XXVIII: SUCCESSORS IN INTEREST

County and Contractor each bind themselves, their partners, successors, assigns and legal representatives to the other party hereto, their partners, successors, assigns and legal representatives in respect to all covenants, agreements, and obligations contained in the contract documents.

ARTICLE XXIX: NOTICE**Giving Notice**

Whenever any provision of the contract documents requires the giving of written notice, it will be deemed to have been validly given if delivered in person to the individual or to a member of the firm or to an officer of the corporation for whom it is intended, or if delivered at or sent registered or certified mail, postage prepaid, to the last business address known to the giver of the notice. The business addresses of Contractor given in the Bid Form and Contractor's office at the site of the work are hereby designated as the places to which all notices, letters, and other communication to Contractor will be delivered. However, County or Contractor may change their addresses at any time by an instrument in writing delivered to the other.

Joint Venture Contractor

In the event the Contractor is a joint venture of two or more Contractors, all grants, covenants, provisos and claims, rights, powers, privileges and liabilities of the contract shall be construed and held to be several as well as joint; any notice, order, direction, request or other communication required to be or that may be given by County to the Contractor under this agreement shall be well and sufficiently given to all persons being the Contractor if given to any one or more of such persons; any notice, request or other communication given by any one of such persons to County under this agreement shall be deemed to have been given by and shall bind all persons being the Contractor.

ARTICLE XXX: VENUE AND JURISDICTION

This contract shall be construed in accordance with the laws of the State of California and the parties agree that venue shall be in Nevada County, California.

IN WITNESS WHEREOF, the parties hereto have signed this Agreement on the date first written, above. One counterpart each has been delivered to County, Contractor, and the Sureties. All portions of the contract documents have been signed or identified by County and Contractor.

COUNTY OF NEVADA

ATTEST:

Clerk of the Board

By: _____
Director of Public Works

CONTRACTOR

By: _____
Licensed in accordance with an act providing for the registration of Contractors
License Number: _____
Fed. Tax ID No: _____
Telephone No: _____